



ELNA ZUBEHÖR

KATALOG 2024



HERZLICH WILLKOMMEN!

Die Marke elna steht seit 80 Jahren für Qualität, Innovation und Service. Für **elna** sind Nähmaschinen nicht nur technische Geräte, sondern lebenslange Begleiter. Selbst wenn Sie schon viel über das Nähen wissen: Erweitern Sie Ihr Können und Ihre Fertigkeiten, indem Sie alle Möglichkeiten Ihrer **elna** Nähmaschine entdecken. Nutzen Sie die richtigen Werkzeuge und Zubehöre für Ihre Nähprojekte.

In diesem Katalog finden Sie **elna** Zubehöre, die Ihre kreativen Fähigkeiten fördern und schwierige Techniken viel einfacher machen.

Nehmen Sie sich die Zeit und besuchen Sie unsere Homepage www.elna.com. Dort finden Sie die Anleitungen unserer verschiedenen Zubehöre. Probieren Sie sie aus und freuen Sie sich über perfekte Resultate.

Entdecken Sie Ihr Nähtalent, entwickeln Sie Ihre Kreativität weiter und teilen Sie Ihre Nähergebnisse mit unserer elna Gemeinschaft!

Danke, dass Sie **elna** gewählt haben.

Inhalt

Nähen, Patchwork und Quilten 5 mm - 7 mm	Seite 4 bis 25
Nähen, Patchwork und Quilten 9 mm	Seite 26 bis 40
Sticken	Seite 41 bis 49
Overlock und Coverstitch	Seite 50 bis 62
Allgemeines Zubehör	Seite 63 bis 78
Die Nadeln	Seite 79 bis 82





NÄHEN, PATCHWORK UND QILTEN ZUBEHÖR

Nähmaschinen mit 5 bis 7 mm Stichbreite

Wenn Sie Nähen lieben und eine Leidenschaft für DIY haben, werden Sie sich über das vielseitige und anwenderfreundliche elna Nähzubehör freuen. Mit diesem Zubehör können Sie das Potential Ihrer Nähmaschine voll nutzen, spezielle Nähtechniken entdecken und Ihr Nähtalent ausbauen.



Zubehöre passend für folgende Nähmaschinen:

Sew Fun, Sew Green, Sew Zebra und Sew 75 (elna 1000)
eXplore 150 und 160
eXplore 220 und 240 (elna 2100, 2110, 2130, 2300)
eXplore 320 und 340 (elna 2600, 2800)
3210 *designed for jeans* (elna 3210, 3230)
elna Star und elna Star Edition
eXperience 450
eXperience 520, 540, 520S, 540S (elna 5100, 5200, 5300)
eXperience 530, 550, 560, 570, 570 α
eXcellence 580 und 580+
elna lotus und lotus 2
eXcellence 720 (elna 7200)

Hinweis: Die Vorgängermodelle der Maschinen aus dem aktuellen Sortiment werden in Klammern angezeigt.



¼" Ruler-Fuß für Modelle mit niedrigem Schaft



Ref.:202-492-005



elna Star, 450, 520/s, 540/s, Lotus 1, 530, 550, 560, 570/α, 660, 620, 720

¼ Inch Saum- und Geradstichfuß (O)

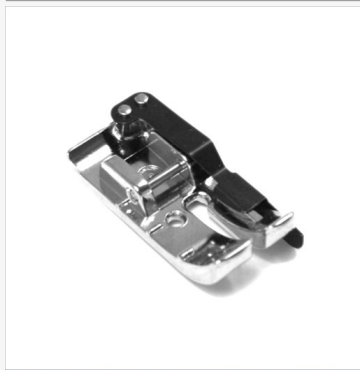

Ref.:200-318-022



150, 160, 320, 340, 3210j, Star, Lotus/2, 450, 520/S, 530, 540/S, 550, 560, 570/α, 580/+, 720

¼ Inch Saum- und Geradstichfuß (O)



Ref.:200-330-020



Sew, 220, 240

¼ Inch-Saumfuß für den Obertransport - I.A.F.-System

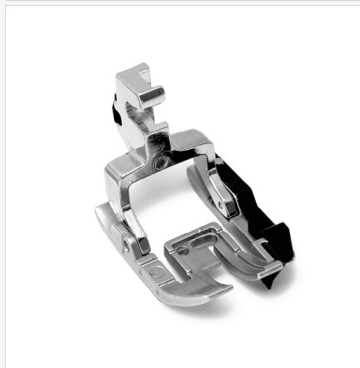

Ref.:846-423-009



720

4-Stufen-Knopflochfuß

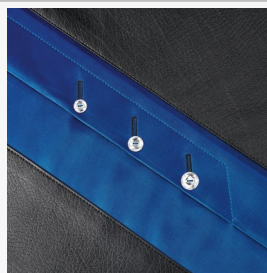

Ref.:200-123-028



Sew, 220, 320

Antihaf Fuß

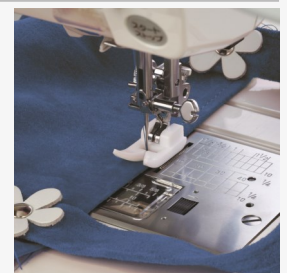

Ref.:200-141-022



Sew, 220, 240

Antihaf Fuß

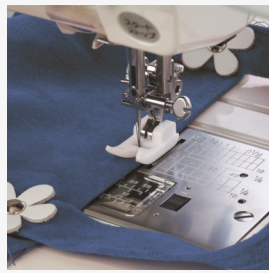

Ref.:200-329-026



150, 160, 220, 240, 320, 340, 3210j, Star, Lotus/2, 450, 520/S, 540/S, 530, 550, 560, 570/α, 580/+, 720

Applikationsfuß (F)

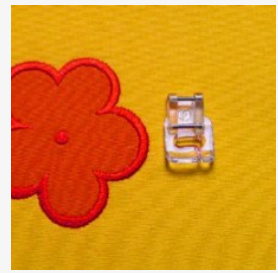

Ref.:202-023-012



150, 160, 320, 340, 3210j, Star, Lotus/2, 450, 520/S, 530, 540/S, 550, 560, 570/α, 580/+, 720

Automatischer Knopflochfuß (R)



Ref.:753-801-004



340, 3210Jeans, Star, Lotus/2, 520/S, 540/S, 520, 540, 620, 660, 720, 740, 580, 580+,

Band- und Paillettenaufnahmefuß

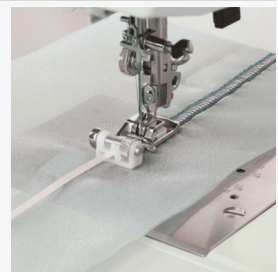

Ref.:200-332-022



150, 160, 320, 340, 3210j, Star, Lotus/2, 450, 520/S, 530, 540/S, 550, 560, 570/α, 580/+, 720

Biesenfuß für schmale Biesen



Ref.:200-328-025



Sew, 220, 240

Bordürenfuß

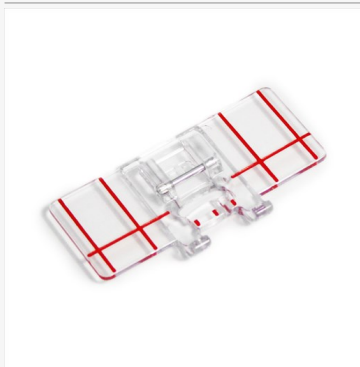

Ref.:200-434-025



150, 160, 320, 340, 3210j, Star, Lotus/2, 450, 520/S, 530, 540/S, 550, 560, 570/α, 580/+, 720

Einfassbandfuß mit Führung (TG)

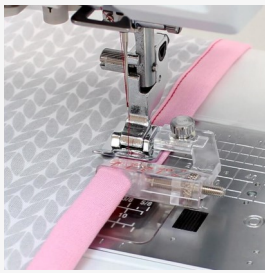

Ref.:202-392-004



150, 160, 320, 340, 3210j, Lotus/2, 450, 520/S, 540/S, 530, 550, 560, 570/α, 580+

Faltenleger mit Klicksystem

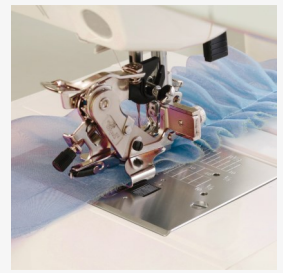

Ref.:846-415-031



150, 160, 320, 340, 3210j, Star, Lotus/2, 450, 520/S, 530, 540/S, 550, 560, 570/α, 580/+, 720

Faltenleger mit Klicksystem



Ref.:943-100-000



150, 160, 220, 240, 320, 340, 3210j, Star, Lotus/2, 450, 520/S, 530, 540/S, 550, 560, 570/α, 580/+,

Faltenleger mit Nadelstangenbefestigung

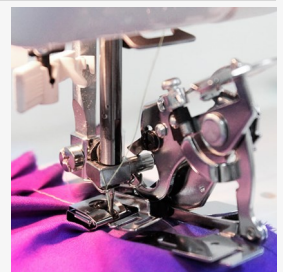

Ref.:941-620-305



Sew, 220, 240

Faltenleger mit Nadelstangenbefestigung

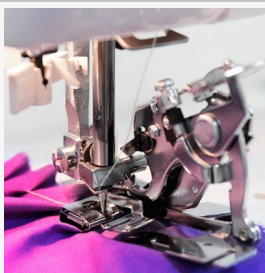

Ref.:941-623-000A



150, 160, 220, 240, 320, 340, 3210j, Lotus/2, 450, 520/S, 540/S, 530, 550, 560, 570/α

Flowerstitcher

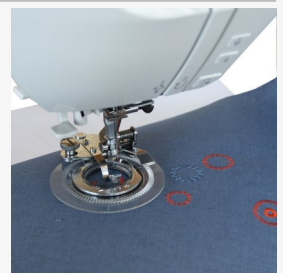

Ref.:202-258-007



150, 160, 220, 240, 320, 340, 3210j, Star, Lotus/2, 450, 520/S, 540/S, 530, 550, 560, 570/α, 720

Fransen- und Schlingenfuß

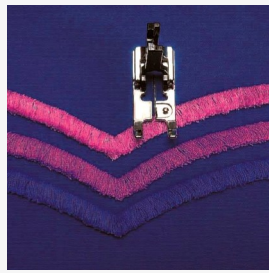

Ref.:200-050-104



580/+, 720

Fransen- und Schlingenfuß

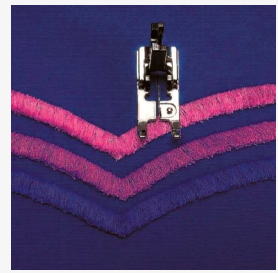

Ref.:200-051-105



Star, Lotus/2, 450, 520/S, 540/S, 530, 550, 560, 570/α

Fransen- und Schlingenfuß

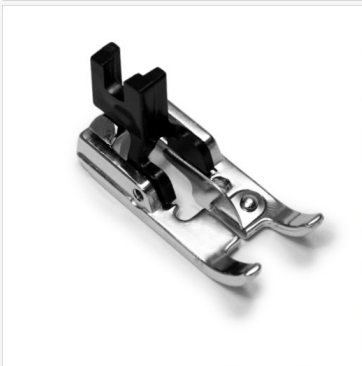

Ref.:200-101-008



Sew, 150, 160, 220, 240, 320, 340, 3210j

Freihand-Plattstickerei-Fuß (FMC)

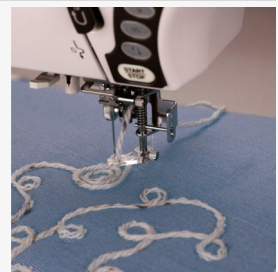

Ref.:202-142-007



580/+

Freihand-Quiltfuß



Ref.:200-442-015



580/+, 720

Geradstichfuß

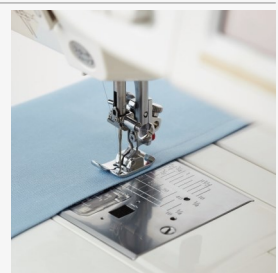
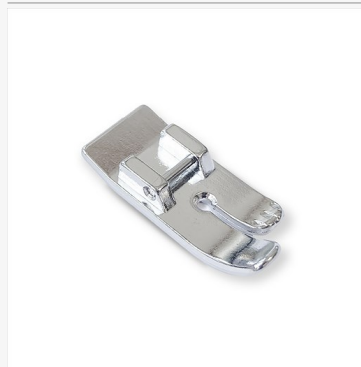

Ref.:200-125-020



Sew, 220, 240

Geradstichfuß



Ref.:200-331-021



150, 160, 320, 340, 3210j, Star, Lotus/2, 450, 520/S, 530, 540/S, 550, 560, 570/α, 580/+, 720

Jersey-Näfuß



Ref.:202-509-006



Sew, 220, 240

Kantenführungsfuß

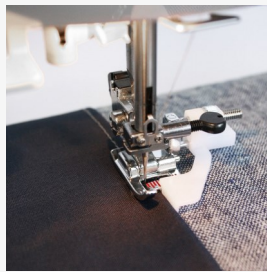

Ref.:202-252-001



150, 160, 320, 340, 3210j, Star, Lotus/2, 450, 520/S, 530, 540/S, 550, 560, 570/α, 580/+, 720

Knopfannähfuß (T)



Ref.:200-131-029



Sew, 220, 240

Knopfannähfuß (T)



Ref.:200-136-024



320, 340, 3210j, Star, Lotus/2, 450, 520/S, 540/S, 530, 550, 560, 570/α, 580/+, 720

Kordelaufnäfuß (H)



Ref.:200-126-021



Sew, 220, 240

Kordelaufnähuß (H)

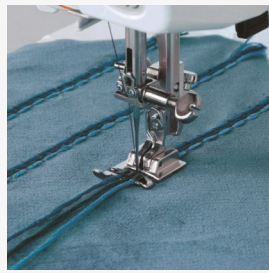

Ref.:200-345-028



150, 160, 320, 340, 3210j, Star, Lotus/2, 450, 520/S, 530, 540/S, 550, 560, 570/α, 580/+, 720

Kräuselfuß (V)

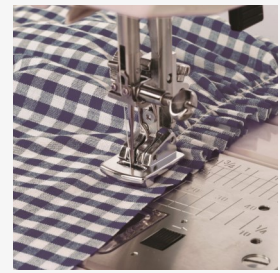

Ref.:200-124-029



Sew, 220, 240

Kräuselfuß (V)

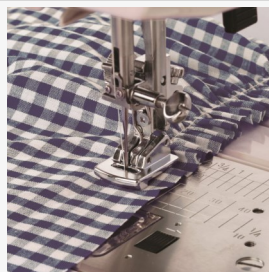

Ref.:200-315-029



150, 160, 320, 340, 3210j, Star, Lotus/2, 450, 520/S, 530, 540/S, 550, 560, 570/α, 580/+, 720

Mittelkantenfuß (G)

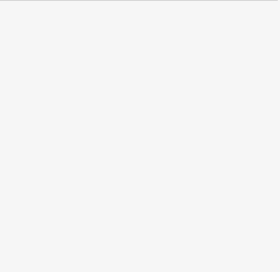
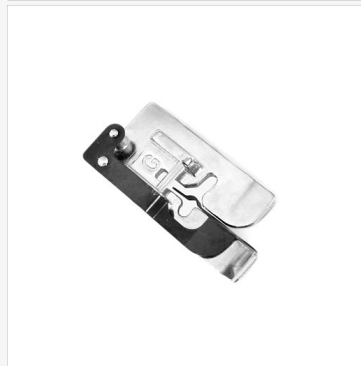

Ref.:395-719-48



150, 160, 220, 240, 320, 340, 3210j, Star, Lotus/2, 450, 520/S, 540/S, 530, 550, 560, 570/α, 580/+, 720

Nahtschattenfuß für den Obertransport - I.A.F.-System



Ref.:846-413-062



720

Nahtschattenfuß

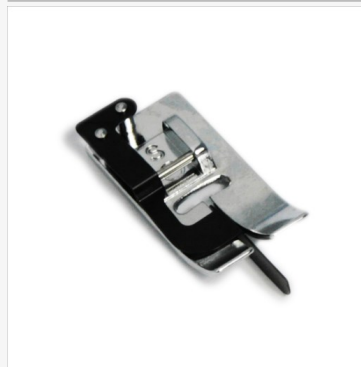

Ref.:200-341-024



150, 160, 320, 340, 3210j, Star, Lotus/2, 450, 520/S, 530, 540/S, 550, 560, 570/α, 580/+, 720

Nahtverdeckter Reißverschlussfuß



Ref.:202-499-002



Sew, 220, 240

Nahtverdeckter Reißverschlussfuß



Ref.:200-333-023



150, 160, 320, 340, 3210j, Star, Lotus/2, 450, 520/S, 530, 540/S, 550, 560, 570/α, 580/+, 720

Obertransport - I.A.F.-System



Ref.:846-407-041



720

Obertransportfuß mit Führungslinial



Ref.:200-309-019



580/+

Obertransportfuß mit Führungslinial



Ref.:200-310-013



Sew, 220, 240

Obertransportfuß mit Führungslinial



Ref.:200-311-014



150, 160, 320, 340, 3210j, Star, Lotus/2, 450, 520/S, 540/S, 530, 550, 560, 570/α

Offener Fuß für den Obertransport
I.A.F.-System

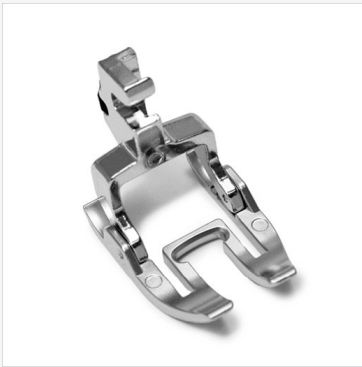

Ref.:846-410-047



720

Offener Obertransportfuß



Ref.:200-048-109



530, 550, 560, 570/α

Offener Obertransportfuß mit
Führungslinial

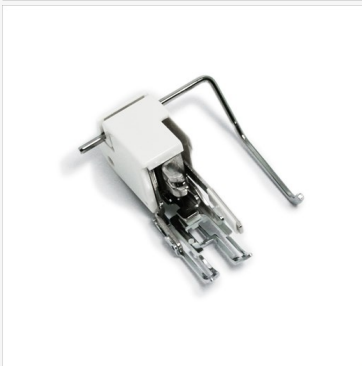

Ref.:200-338-028



580/+

Offener Obertransportfuß mit
Führungslinial

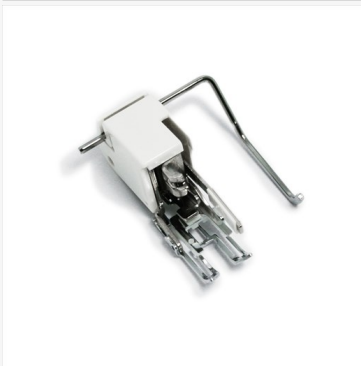

Ref.:200-339-029



150, 160, 320, 340, 3210j, Star, Lotus/2, 450, 520/S, 540/S, 530, 550, 560, 570/α

Offener Satinstichfuß



Ref.:200-137-025



150, 160, 320, 340, 3210j, Star, Lotus/2, 450, 520/S, 530, 540/S, 550, 560, 570/α, 580/+, 720

Offener Stick- und Stopffuß

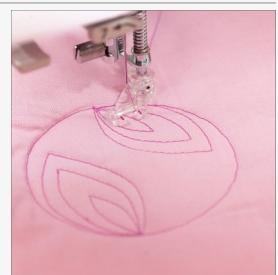
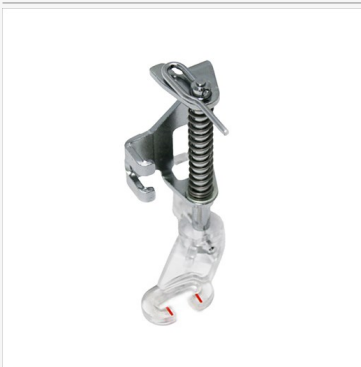

Ref.:200-340-023



150, 160, 320, 340, 3210j, Star, Lotus/2, 450, 520/S, 540/S, 530, 550, 560, 570/α

Offener Stick- und Stopffuß PD-H



Ref.:200-337-027



Overlockfuß (C)

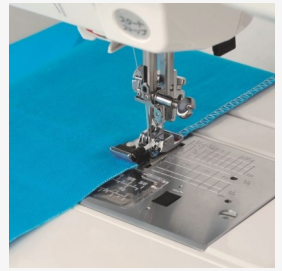

Ref.:822-801-001

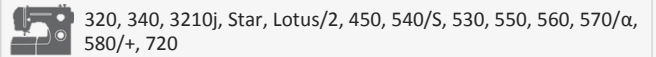

Overlockfuß (G)



Ref.:200-132-020

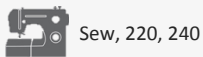

Overlockfuß (M)

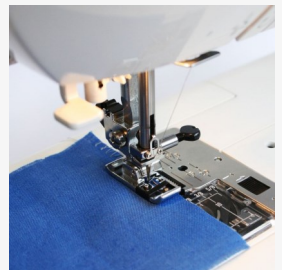

Ref.:822-808-008

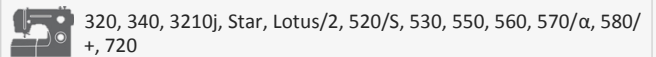

Paspelfuß

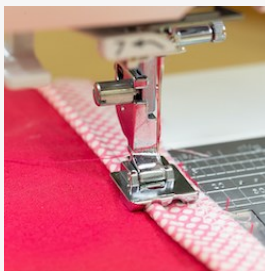

Ref.:200-314-028

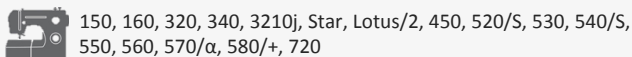

Perlennähfuß für Perlen in der Größe von 2 mm bis 4 mm



Ref.:200-321-028

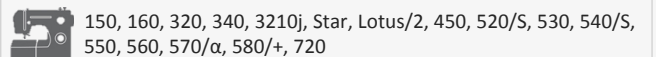

Rollenfuß für Leder und Kunstleder



Ref.:200-142-023



Sew, 220, 240

Rollenfuß für Leder und Kunstleder

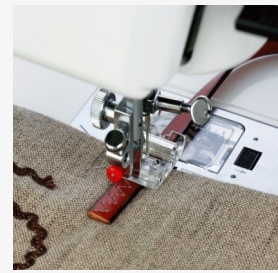

Ref.:200-316-020



150, 160, 320, 340, 3210j, Star, Lotus/2, 450, 520/S, 530, 540/S, 550, 560, 570/α, 580/+ , 720

Rollenfuß HD



Ref.:202-420-002



580/+

Rollsaumfuß (D)

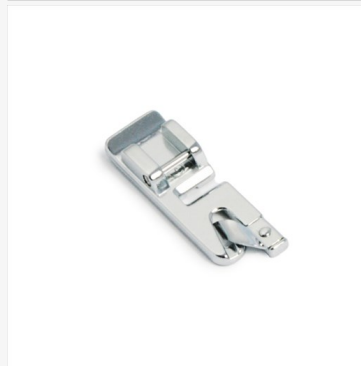

Ref.:202-251-000



Sew, 220, 240

Rollsaumfuß 3mm (D)



Ref.:820-809-014



150, 160, 3210j, Lotus/2, 450, 520/S, 540/S, 530, 550, 560, 570/α, 580+

Rollsaumfuß-Set mit 2 Füße: für 4 und 6mm Rollsaum

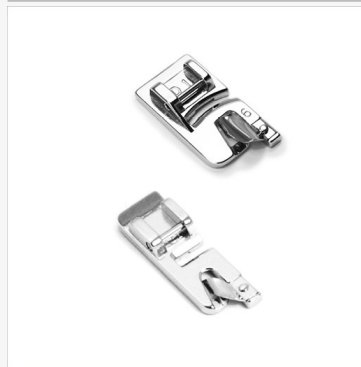

Ref.:200-326-023



150, 160, 320, 340, 3210j, Star, Lotus/2, 450, 520/S, 530, 540/S, 550, 560, 570/α, 580/+ , 720

Satinstichfuß (F)



Ref.:200-129-024



Sew, 220, 240

Satinstichfuß (F)

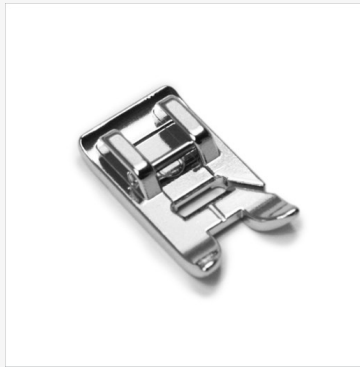

Ref.:822-804-118



320, 340, 3210Jeans, Star, Lotus/2, 450, 520/S, 540/S, 520, 540, 530, 550, 560, 570, 570/α, 620, 660, 720, 740, 580, 580+

Schnurfuß



Ref.:494-660-15



Sew, 220, 240

Schrägbandfuß

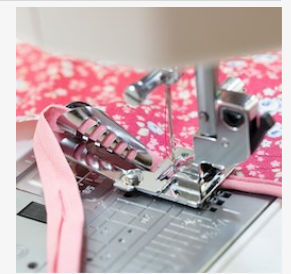

Ref.:200-140-021



Sew, 220, 240

Schrägbandfuß

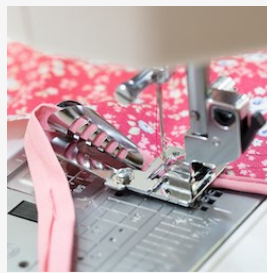

Ref.:200-313-027



150, 160, 320, 340, 3210j, Star, Lotus/2, 450, 520/S, 530, 540/S, 550, 560, 570/a, 580, 580+, 720

Standard-Metallfuß (A)



Ref.:611-511-001



Sew, 150, 160, 220, 240

Standard-Metallfuß (A)

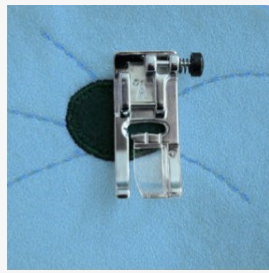

Ref.:825-510-032



320, 340, 3210j, Star, Lotus/2, 450, 520/S, 540/S, 530, 550, 560, 570/α, 580/+, 720

Standard-Reißverschlussfuß (E)



Ref.:808-852-003



320, 340, 3210Jeans, Star, Lotus/2, 450, 520/S, 540/S, 520, 540, 530, 550, 560, 570, 570/α, 620, 660, 720, 740, 580, 580+

Stick- und Stopffuß



Ref.:200-127-022



Sew, 220, 240

Stick- und Stopffuß

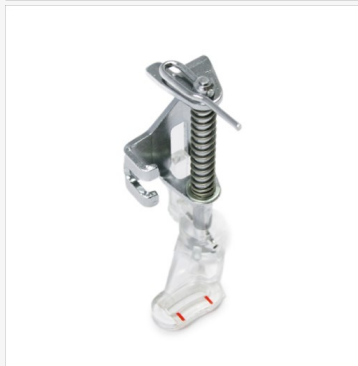

Ref.:200-325-022



580/+, 720

Stick- und Stopffuß



Ref.:200-349-022



150, 160, 320, 340, 3210j, Star, Lotus/2, 450, 520/S, 540/S, 530, 550, 560, 570/α

Transparenter Zickzackfuß mit Fingerschutz



Ref.:749-522-005



150, 160, 320, 340, 3210j, Lotus/2, 450, 520/S, 540/S, 530, 550, 560, 570/α, 580+

Verschiebbarer Führungsfuß



Ref.:202-221-001



320, 340, 3210j, Star, Lotus/2, 450, 520/S, 530, 540/S, 550, 560, 570/α, 580/+, 720

Verstellbarer 4-Stufen-Knopflochfuß



Ref.:200-134-022



Sew, 220, 320

Verstellbarer Blindstichfuß (G)



Ref.:820-817-015



150, 160, 220, 240, 320, 340, 3210j, Star, 450, 520/S, 540/S, 530, 550, 560, 570/α, 580/+, 720

Verstellbarer Blindstichfuß (L)



Ref.:200-130-028



Sew, 220, 240

Verstellbarer Reißverschlussfuß



Ref.:200-334-024



580/+, 740

Verstellbarer Reißverschlussfuß



Ref.:200-342-025



Sew, 150, 160, 220, 240, 320, 340, 3210j, Star, Lotus/2, 450, 520/S, 540/S, 530, 550, 560, 570/α

XXL-Knopfloch-Fuß



Ref.:820-801-016



320, 340, 3210j, Star, Lotus/2, 450, 520/S, 540/S, 530, 550, 560, 570/α, 580/+

Biesenfuß - schmal und breit

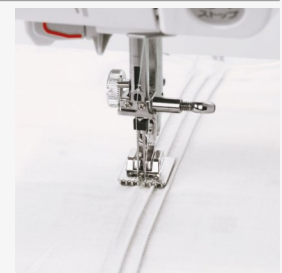
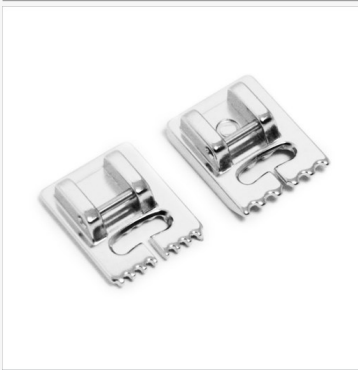

Ref.:200-317-021



150, 160, 320, 340, 3210j, Star, Lotus/2, 450, 520/S, 530, 540/S,

Freihand-Quiltfuß-Set mit Rulerfuß

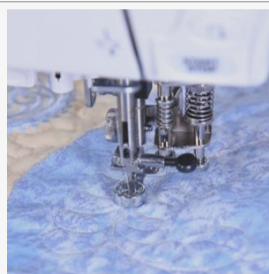

Ref.:767-434-016



150, 160, Star, Lotus/2, 520/S, 530, 540/S, 550, 560, 570/α, 580/+, 720
Nur als Ergänzung zu 202-002-015 / 202-001-014

Freihand-Quiltfuß-Set (enthält Halter und geschlossenen, offenen und transparenten Fuß)

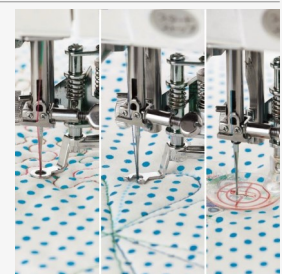

Ref.:202-001-014



580/+, 720

Freihand-Quiltfuß-Set (enthält Halter und geschlossenen, offenen und transparenten Fuß)

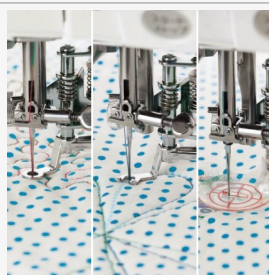

Ref.:202-002-015



150, 160, 3210j, Star, Lotus/2, 450, 520/S, 540/S, 530, 550, 560, 570/α

Obertransportfuß-Wechselset



Ref.:214-516-014



580/+

Nähen, Patchwork und Quilten 5-7mm

Obertransportfuß-Wechselset



Ref.:214-517-015

 150, 160, 320, 340, 3210j, Star, Lotus/2, 450, 520/S, 540/S, 530, 550, 560, 570/α

Transparentes Quiltfuß-Set mit Führung

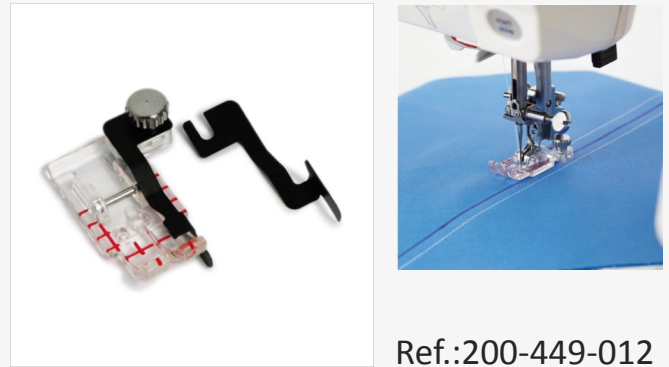

Ref.:200-449-012

 150, 160, 320, 340, 3210j, Star, Lotus/2, 450, 520/S, 530, 540/S, 550, 560, 570/α, 580/+, 720

Bandführung breit



Ref.:200-444-419

 150, 160, 320, 340, Star, Lotus/2, 450, 520/S, 540/S, 530, 550, 560, 570/α, 580/+

Biesen-Kordelführung - breit



Ref.:503-809-001

 150, 160, 3210j, 450, Lotus/2

Biesen-Kordelführung - schmal



Ref.:503-810-005

 150, 160, 3210j, 450, Lotus/2

Führungslinial



Ref.:802-422-002

 150, 160, 320, 340, 3210j, Star, Lotus/2, 450, 520/S, 530, 540/S, 550, 560, 570/α, 580/+

Knopfloch-Stabilisierungsplatte für den automatischen Knopflochfuß (R)



Ref.:202-030-001



240, 340, 3210j, Star, Lotus/2, 520/S, 540/S, 530, 550, 560, 570/α, 580/+, 720
For 7mm models use plate holder 200-428-406

Quilt und Bandenfass-Set

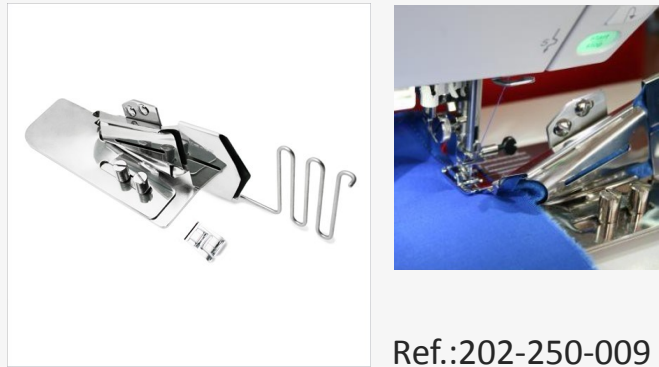

Ref.:202-250-009



Lotus/2, 580/+, 720

Stoffführung T



Ref.:200-100-100



150, 160, 220, 240, 320, 340, 3210j, 450, 520/S, 540/S, 530, 550, 560, 570/α, Lotus/2, 580/+

Biesen-Kordelführungen Set – schmal und breit



Ref.:200-324-021



320, 340, Star, 520/S, 540/S

Biesen-Kordelführungen Set – schmal und breit



Ref.:202-238-001



530, 550, 560, 570/α, 580/+

Führungslinial und Nahtschatten-Führungsset



Ref.:202-249-005



150, 160, 220, 240, 320, 340, 3210j, Star, Lotus/2, 450, 520/S, 530, 540/S, 550, 560, 570/α, 580/+

Führungslinial-Set lang



Ref.:202-025-405



150, 160, 320, 340, 3210j, Star, Lotus/2, 450, 520/S, 530, 540/S, 550, 560, 570/α, 580/+

Geradstich-Stichplatte



Ref.:200-088-101



520/S, 540/S

Geradstich-Stichplatte



Ref.:503-821-009



3210j

Geradstich-Stichplatte



Ref.:809-833-012



530, 550, 560, 570/α, Lotus/2, 580+

Geradstich-Stichplatte



Ref.:846-833-109



720

Kreisnähführung

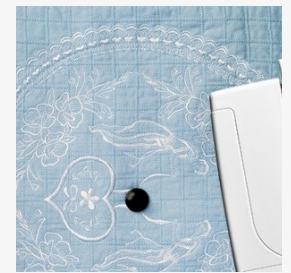

Ref.:202-106-009



3210j, 720

Kreisnähführung

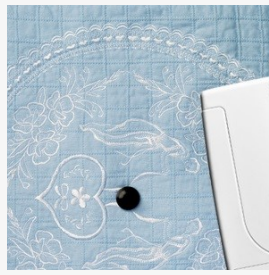

Ref.:202-107-000



320, 340, Star, 520/S, 540/S

Kreisnähführung



Ref.:202-242-008



530, 550, 560, 570/α, 580/+

Spulenhalter für Stick- und Ziergarn
(Bobbin Stickerei)

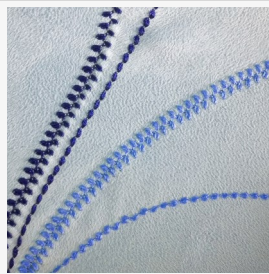

Ref.:200-056-007



320, 340, 3210j, Star, 450, 520/S, 540/S

Spulenhalter zum Freihand-Quilten

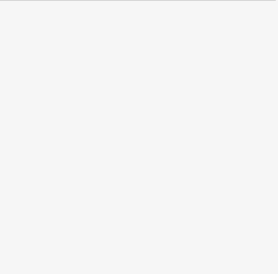
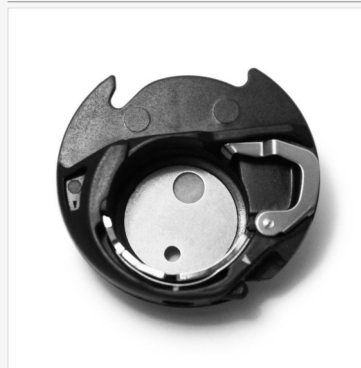

Ref.:200-445-029



530, 550, 560, 570/α, Lotus/2, 580/+

Spulenhalter zum Freihand-Quilten



Ref.:202-006-019



150, 160, 320, 340, 3210j, Star, 450, 520/S, 540/S

Gummibandkräusler - 10 mm breit

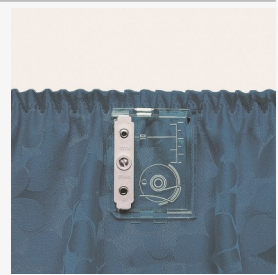

Ref.:495-845-20



320, 340, Star, 520/S, 540/S

Gummibandkräusler - 10 mm breit

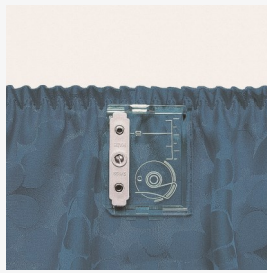

Ref.:495-846-20



3210j, 450, Lotus/2, 720

Gummibandkräusler - 13 mm breit



Ref.:495-525-20



320, 340, Star, 520/S, 540/S

Gummibandkräusler - 13 mm breit

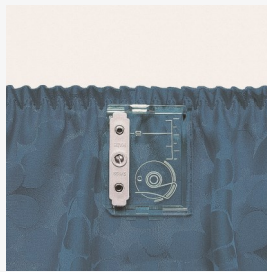

Ref.:495-526-20



3210j, 450, Lotus/2, 720

Gummibandkräusler - 8 mm breit

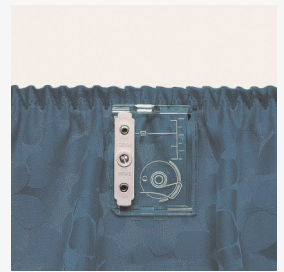

Ref.:495-390-20



320, 340, Star, 520/S, 540/S

Gummibandkräusler - 8 mm breit

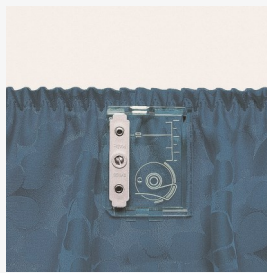

Ref.:495-395-20



150, 160, 3210j, 450, Lotus/2, 720

Hohlsaumplättchen breit 5 mm

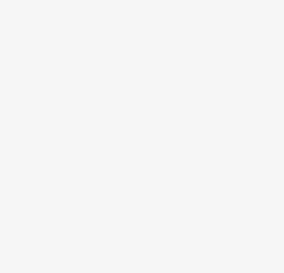

Ref.:395-731-59



3210j, Lotus/2, 720

Hohlsaumplättchen schmal 2,5 mm



Ref.:395-731-58



3210j, 450, Lotus/2, 720

Hohlsaumplättchen schmal 2,5 mm



Ref.:495-560-20



320, 340, Star, 520/S, 540/S

Abnehmbare Lupe (1.2x)



Ref.:202-399-001



530, 550, 560, 570/α, 580/+

Abnehmbares Lupen-Set 1.2x, 1.4x and 1.6x.



Ref.:202-157-005



530, 550, 560, 570/α, 580/+



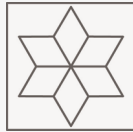

NÄHEN, PATCHWORK UND QUILTEN ZUBEHÖR

Nähmaschinen mit 9 mm Stichbreite

In diesem Bereich präsentieren wir Ihnen unsere Kollektion von Nähzubehör für bestimmte Nähanwendungen, die wir für unsere Premium Computer-Nähmaschinen entwickelt haben. Diese leistungsstarken Maschinen bieten eine Vielzahl hochwertiger Nähfunktionen und einen extragroßen Nähbereich für einen außergewöhnlichen Nähkomfort.

Erweitern Sie die Möglichkeiten Ihrer elna Nähmaschine mit unserem reichhaltigen Zubehörsortiment. Finden Sie das perfekte Werkzeug für Ihr Projekt und freuen Sie sich über
Über ein optimales Ergebnis.



Zubehöre passend für folgende Nähmaschinen:

eXcellence 680 und 680+
eXcellence 710
eXcellence 720PRO
eXcellence 730 und 730PRO
eXcellence 760 und 760PRO
eXcellence 770
eXcellence 782
eXcellence 780 und 780+
eXcellence 790PRO und 792PRO

¼" Ruler-Fuß für 9 mm/7 mm Modelle mit hohem Schaft



Ref.: 202-493-006

580/+, 680/+, 710, 720PRO, 740, 730/PRO, 760/PRO, 770, 780/+, 782, 790PRO, 792PRO, 900, 920

¼ inch Klarsichtfuß für die Geradstich-Stichplatte (OM)

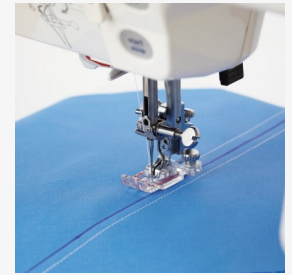

Ref.: 202-239-002

680/+, 710, 720PRO, 730/PRO, 760/PRO, 770, 780/+, 782, 790PRO, 792PRO, 850, 860, 900, 920

¼ Inch Profigeradstichfuß HP



Ref.: 865-803-006

770

¼ Inch Saum- und Geradstichfuß (O)



Ref.: 859-814-012

680/+, 720PRO, 730/PRO, 760/PRO, 770, 780/+, 850, 860, 920

¼ Inch Saum- und Geradstichfuß ohne Führung (O)



Ref.: 202-313-104

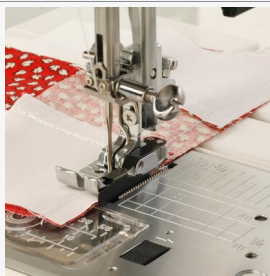

680/+, 710, 720PRO, 730/PRO, 760/PRO, 770, 780/+, 850, 860, 900, 920

9-Loch Kordelfuß H2

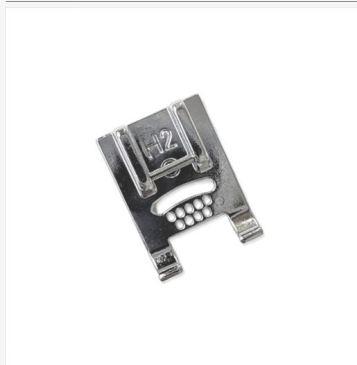

Ref.: 202-507-004

782, 792PRO

Antihafffuß (U)

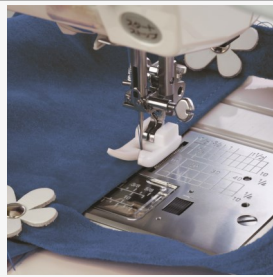

Ref.: 202-091-206

680/+, 710, 720PRO, 730/PRO, 760/PRO, 770, 780/+, 782, 790PRO, 792PRO, 850, 860, 900, 920

Applikationsfuß (AP)

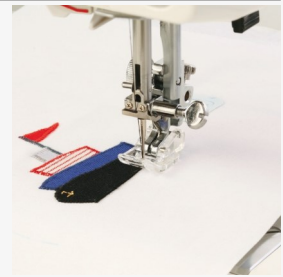

Ref.: 202-086-208

680/+, 710, 720PRO, 730/PRO, 760/PRO, 770, 780/+, 782, 790PRO, 792PRO, 850, 860, 900, 920

Band- und Paillettenaufnahmefuß (RS)



Ref.: 202-090-205

680/+, 710, 720PRO, 730/PRO, 760/PRO, 770, 780/+, 782, 790PRO, 792PRO, 850, 860, 900, 920

Biesenfuß für breite Biesen (N1)

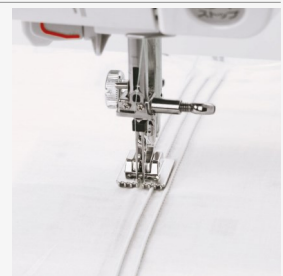
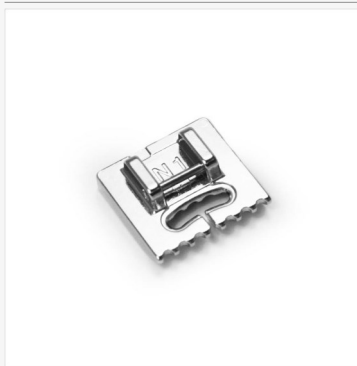

Ref.: 202-093-208

680/+, 710, 720PRO, 730/PRO, 760/PRO, 770, 780/+, 782, 790PRO, 792PRO, 850, 860, 900, 920

Biesenfuß für schmale Biesen (N2)



Ref.: 202-094-209

680/+, 710, 720PRO, 730/PRO, 760/PRO, 770, 780/+, 782, 790PRO, 792PRO, 850, 860, 900, 920

BI-Level Fuß



Ref.: 202-488-008

680/+, 710, 720PRO, 730/PRO, 760/PRO, 770, 780/+, 782, 790PRO, 792PRO, 850, 860, 900, 920

Doppeltransportfuß Dual Feed (AD)



Ref.: 859-819-017



720PRO, 730/PRO, 760/PRO, 770, 780/+, 920

Einfassbandfuß mit Führung (TG)

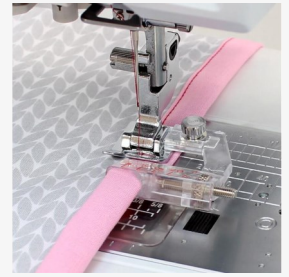

Ref.: 202-391-003



680/+, 720PRO, 730/PRO, 760/PRO, 770, 780/+, 782, 792PRO, 850, 860, 900, 920

Faltenleger

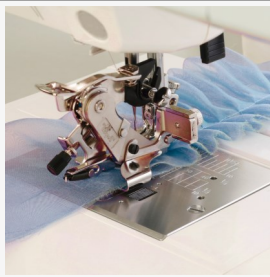

Ref.: 202-095-200



680/+, 710, 720PRO, 730/PRO, 760/PRO, 770, 780/+, 782, 790PRO, 792PRO, 850, 860, 900, 920

Freihand-Plattstickerei-Fuß (FMC)



Ref.: 202-142-007



680/+, 710, 720PRO, 730/PRO, 760/PRO, 770, 780/+, 782, 790PRO, 792PRO, 850, 860, 900, 920

Freihand-Quiltfuß geschlossen (QC)

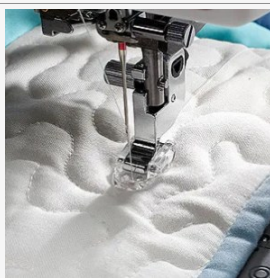

Ref.: 859-836-009



770, 780/+, 920

Freihand-Quiltfuß offen (QO)

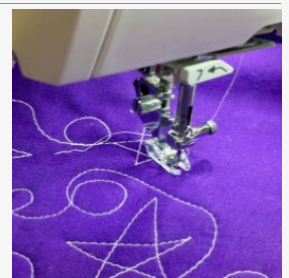

Ref.: 859-837-000



770, 780/+, 920

Geradstichfuß (ST)

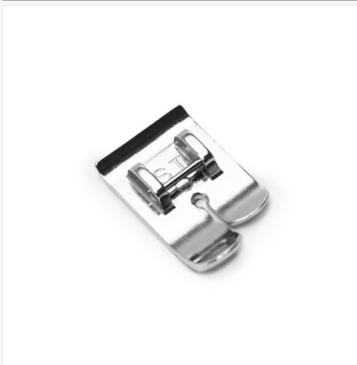

Ref.: 202-083-205



680/+, 710, 720PRO, 730/PRO, 760/PRO, 770, 780/+, 782, 790PRO, 792PRO, 850, 860, 900, 920

Kantenführungsfuß (SE)



Ref.: 202-100-209



680/+, 710, 720PRO, 730/PRO, 760/PRO, 770, 780/+, 782, 790PRO, 792PRO, 850, 860, 900, 920

Kappnahtfuß



Ref.: 202-490-003



680/+, 710, 720PRO, 730/PRO, 760/PRO, 770, 780/+, 782, 790PRO, 792PRO, 850, 860, 900, 920

Knopflochfuß extragroß mit Stabilisierungsplatte

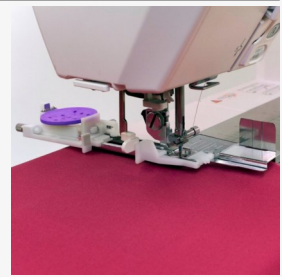

Ref.: 202-312-000



680/+, 710, 720PRO, 730/PRO, 760/PRO, 770, 780/+, 790PRO, 792PRO, 850, 860, 920

Kordelaufnähuß (H)

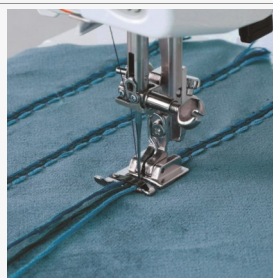

Ref.: 202-085-207



680/+, 710, 720PRO, 730/PRO, 760/PRO, 770, 780/+, 782, 790PRO, 792PRO, 850, 860, 900, 920

Kräuselfuß (V)

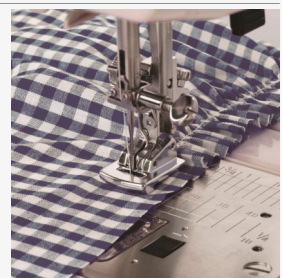

Ref.: 202-096-201



680/+, 710, 720PRO, 730/PRO, 760/PRO, 770, 780/+, 782, 790PRO, 792PRO, 850, 860, 900, 920

Nahtschattenfuß (S)



Ref.: 202-087-209



680/+, 710, 720PRO, 730/PRO, 760/PRO, 770, 780/+, 782, 790PRO, 792PRO, 850, 860, 900, 920

Nahtverdeckter Reißverschlussfuß (Z)



Ref.: 202-156-004



680/+, 710, 720PRO, 730/PRO, 760/PRO, 770, 780/+, 850, 860, 900, 920

Obertransportfuß Dual Feed mit offener Nähsohle – breit (UD)



Ref.: 202-236-009



710, 720PRO, 730/PRO, 760/PRO, 770, 780/+, 782, 790PRO, 792PRO, 900, 920

Obertransportfuß Dual Feed Plus mit Halter – schmal (VD)

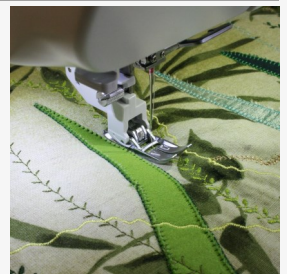

Ref.: 202-257-006



710, 720PRO, 730/PRO, 760/PRO, 770, 780/+, 782, 790PRO, 792PRO, 900, 920

Obertransport-Geradstichsohle Dual Feed – breit (STD)

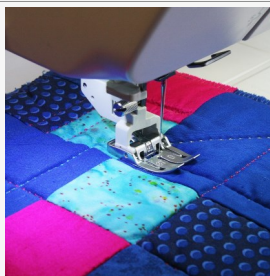

Ref.: 202-102-201



710, 720PRO, 730/PRO, 760/PRO, 770, 780/+, 782, 790PRO, 792PRO, 900, 920

Obertransport-Nahtschattensohle Dual Feed – breit (SD)

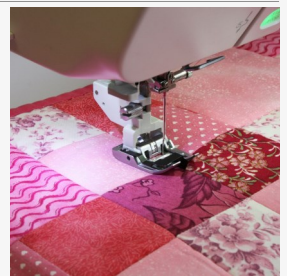

Ref.: 202-103-202



710, 720PRO, 730/PRO, 760/PRO, 770, 780/+, 782, 790PRO, 792PRO, 900, 920

Obertransport-Patchworksohle ¼ Inch
Dual Feed – breit (OD)



Ref.: 202-235-008



710, 720PRO, 730/PRO, 760/PRO, 770, 780/+, 782, 790PRO, 792PRO, 900, 920

Obertransport-Reißverschlussfuß Dual
Feed Plus – schmal (ED)



Ref.: 202-155-003



710, 720PRO, 730/PRO, 760/PRO, 770, 780/+, 782, 790PRO, 792PRO, 900, 920

Offener Satinstichfuß (F2)



Ref.: 859-813-000



680/+, 720PRO, 770, 780/+, 850, 860, 920

Offener Stick- und Stopffuß PD-H

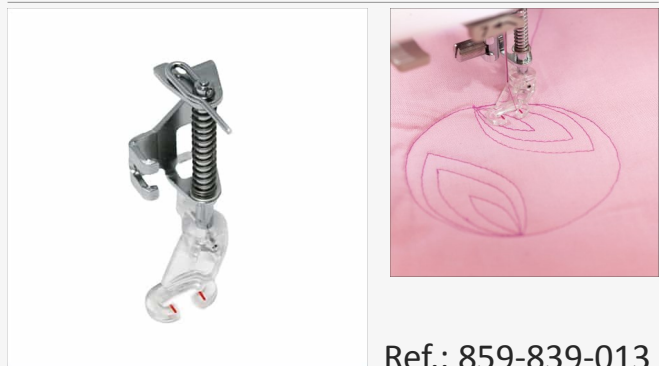

Ref.: 859-839-013



680/+, 710, 720PRO, 770, 780/+, 850, 860, 920

Paspelfuß (I) - Max. 5 mm Paspelbreite

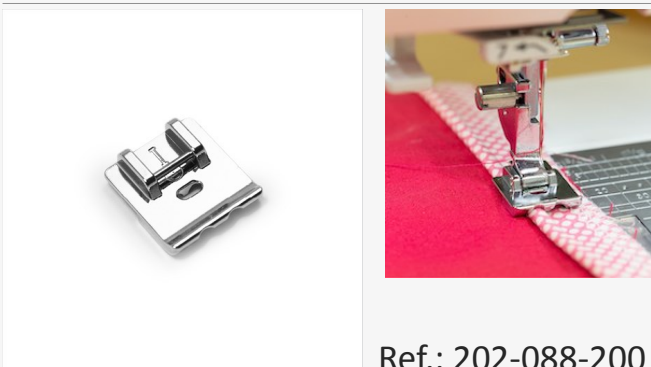

Ref.: 202-088-200



680/+, 710, 720PRO, 730/PRO, 760/PRO, 770, 780/+, 782, 790PRO, 792PRO, 850, 860, 900, 920

Paspelfuß (schmal) - Max. 3 mm
Paspelbreite



Ref.: 202-489-009



680/+, 710, 720PRO, 730/PRO, 760/PRO, 770, 780/+, 782, 790PRO, 792PRO, 850, 860, 900, 920

Perlernaufnahmefuß für Perlen in der Größe von 2 mm (L1)

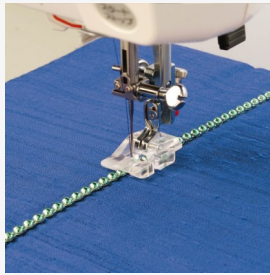

Ref.: 202-097-202



680/+, 710, 720PRO, 730/PRO, 760/PRO, 770, 780/+, 782, 790PRO, 792PRO, 850, 860, 900, 920

Perlernaufnahmefuß für Perlen in der Größe von 2,5 bis 4 mm (L2)

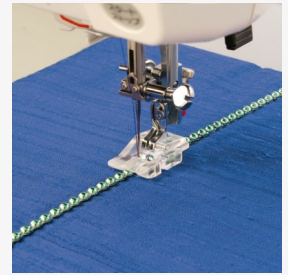

Ref.: 202-098-203



680/+, 710, 720PRO, 730/PRO, 760/PRO, 770, 780/+, 782, 790PRO, 792PRO, 850, 860, 900, 920

Profigeradstichfuß Dual Feed Plus schmal (HP2)



Ref.: 202-416-005



720PRO, 770, 780/+, 920

Rollenfuß HD

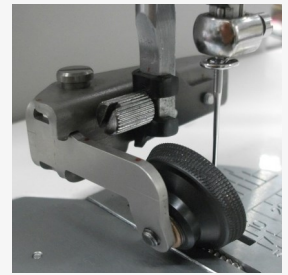

Ref.: 202-420-002



680/+, 720PRO, 730/PRO, 760/PRO, 770, 780/+, 782, 790PRO, 792PRO, 850, 860, 920

Rollsaumfuß 4 mm (D2)



Ref.: 202-081-203



680/+, 710, 720PRO, 730/PRO, 760/PRO, 770, 780/+, 782, 790PRO, 792PRO, 850, 860, 900, 920

Rollsaumfuß 6 mm (D1)

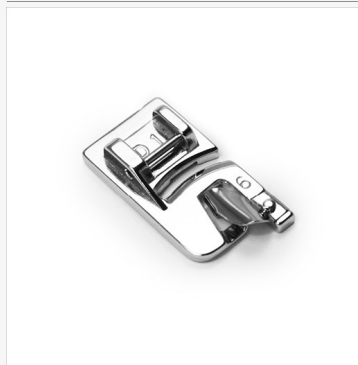

Ref.: 202-080-202



680/+, 710, 720PRO, 730/PRO, 760/PRO, 770, 780/+, 782, 790PRO, 792PRO, 850, 860, 900, 920

Ruler-Fuß mit QB-S Fußhalter



Ref.: 858-820-029



770, 780

Schrägbandfuß (W)

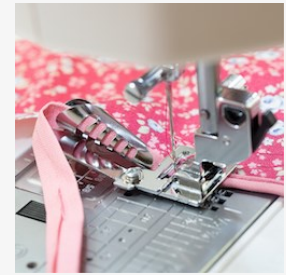

Ref.: 202-099-204



680/+, 710, 720PRO, 730/PRO, 760/PRO, 770, 780/+, 782, 790PRO, 792PRO, 850, 860, 900, 920

Stickfuß mit Führung (FB)

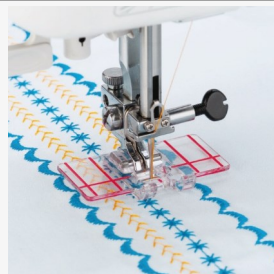

Ref.: 202-084-206



680/+, 710, 720PRO, 730/PRO, 760/PRO, 770, 780/+, 782, 790PRO, 792PRO, 850, 860, 900, 920

Transparenter Freihand-Quiltfuß(QV)



Ref.: 859-812-009



770, 780/+, 920

Variabler Zick-Zackstich-Fuß (QZ)



Ref.: 862-895-006



770, 780/+, 920

Verschiebbarer Führungsfuß



Ref.: 202-294-005



680/+, 710, 720PRO, 730/PRO, 760/PRO, 770, 780/+, 790PRO, 792PRO, 850, 860, 920

Verstellbarer Reißverschlussfuß



Ref.: 200-334-024



680/+, 720PRO, 730/PRO, 760/PRO, 770, 780/+, 782, 850, 860, 900, 920

XXL-Knopfloch-Fuß (B)



Ref.: 202-082-204



680/+, 710, 720PRO, 730/PRO, 760/PRO, 770, 780/+, 782, 790PRO, 792PRO, 850, 860, 900, 920

Antihaf Fuß und Antihafstichplatte



Ref.: 202-237-000



680/+, 710, 720PRO, 730/PRO, 760/PRO, 770, 780/+, 782, 850, 860, 900, 920

Antihaf Fuß und Antihafstichplatte

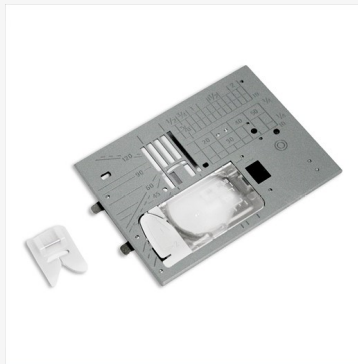

Ref.: 202-497-000



790PRO, 792PRO

Freihand-Quiltfuß-Set mit Rulerfuß

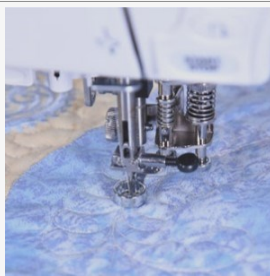

Ref.: 767-434-016



680/+, 720PRO, 730/PRO, 760/PRO, 850, 860 - nur bei Verwendung der Halter 858-820-018

Freihand-Quiltfuß-Set (enthält Halter und geschlossenen, offenen und transparenten Fuß)

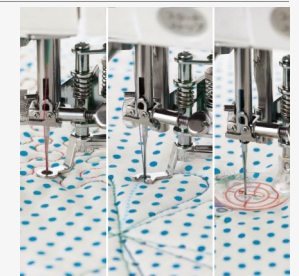

Ref.: 202-243-009



680/+, 720PRO, 730/PRO, 760/PRO, 850, 860

Obertransportfuß-Wechselset

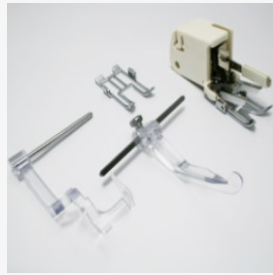

Ref.: 202-234-007



680/+, 850, 860

Transparentes Quiltfuß-Set mit Führung (OV)

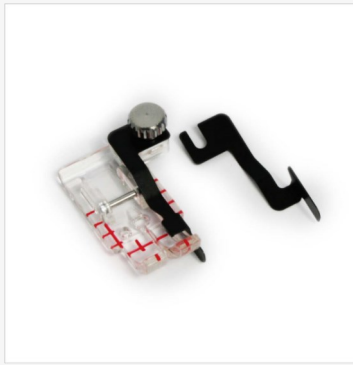

Ref.: 202-089-201



680/+, 710, 720PRO, 730/PRO, 760/PRO, 770, 780/+, 782, 790PRO, 792PRO, 850, 860, 900, 920

Bandführung breit

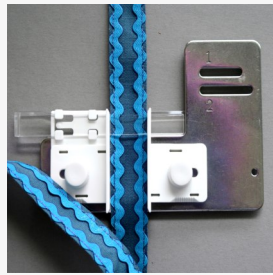

Ref.: 200-444-419



680/+, 710, 720PRO, 730/PRO, 760/PRO, 770, 780/+, 782, 790PRO, 792PRO, 850, 860, 920

Biesen-Kordelführung - breit



Ref.: 503-809-001



900

Biesen-Kordelführung - schmal



Ref.: 503-810-005



900

Führungslinial



Ref.: 755-802-001



680/+, 720PRO, 770, 780/+, 850, 860, 920

Nähen, Patchwork und Quitten 9mm

Stoffführung T



Ref.: 200-100-100



680/+, 720PRO, 770, 780/+, 782, 792PRO, 850, 860, 920

Stoffführung



Ref.: 858-401-008



770

Biesen-Kordelführungen Set – schmal und breit



Ref.: 202-238-001



680/+, 710, 720PRO, 730/PRO, 760/PRO, 770, 780/+, 782, 790PRO, 792PRO, 850, 860, 920

Führungslineal und Nahtschatten-Führungsset



Ref.: 202-249-005



680/+, 850, 860

Führungslineal-Set lang



Ref.: 202-025-405



680/+, 710, 720PRO, 730/PRO, 760/PRO, 770, 780/+, 790PRO, 792PRO, 850, 860, 900, 920

Quilt und Bandeinfass-Set (W1)



Ref.: 202-245-001

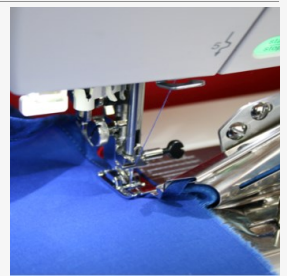

680/+, 710, 720PRO, 730/PRO, 760/PRO, 770, 780/+, 782, 790PRO, 792PRO, 850, 860, 920

Quilt und Bandeinfass-Set(W1)

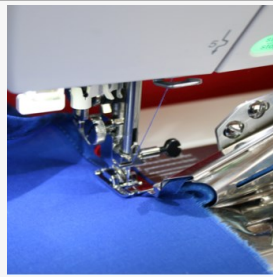

Ref.: 202-101-200



900

Geradstich-Stichplatte

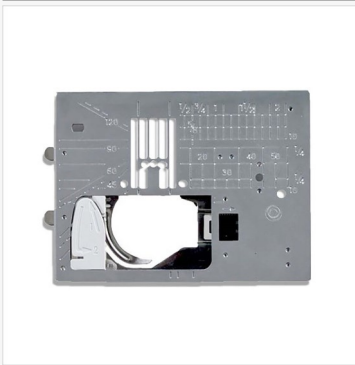

Ref.: 861-801-013



850, 860

Profi-Geradstich-Stichplatte HP

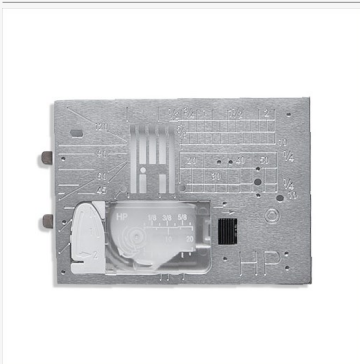

Ref.: 865-805-019



770

Kreisnähführung

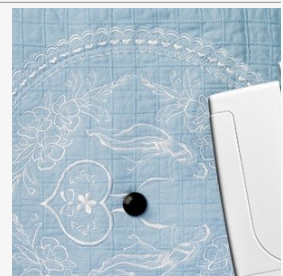

Ref.: 202-242-008



680/+, 710, 720PRO, 730/PRO, 760/PRO, 770, 780/+, 782, 790PRO, 792PRO, 850, 860, 900, 920

Spulenhalter zum Freihand-Quilten



Ref.: 200-445-029



680/+, 720PRO, 730/PRO, 760/PRO, 770, 780/+, 782, 850, 860, 900, 920

Stitch Composer software

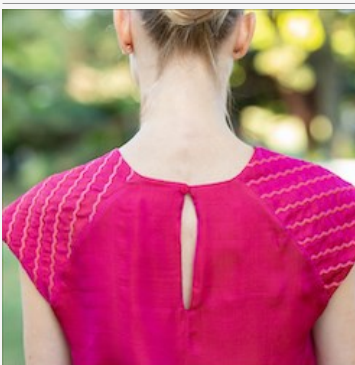

Ref.: 861-827-004



770

Upgrade-Set für eXcellence 770 und 780 Enthält Software-Update & 4 Nähfüße



Ref.: 865-403-002



770, 780

Abnehmbare Lupe (1.2x)



Ref.: 202-399-001



680/+, 720PRO, 730PRO, 760PRO, 770, 780/+, 782, 792PRO, 850, 860, 920

Abnehmbares Lupen-Set 1.2x, 1.4x and 1.6x.



Ref.: 202-157-005



680/+, 710, 730/PRO, 760/PRO, 770, 780/+, 782, 850, 860, 900, 920

Abnehmbares Lupen-Set 1.2x, 1.4x and 1.6x.

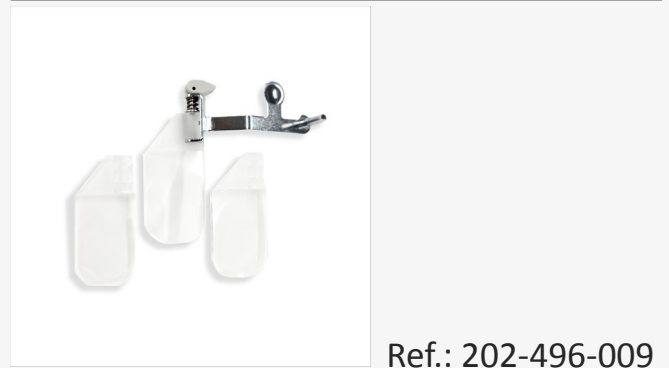

Ref.: 202-496-009



790PRO, 792PRO





STICK-ZUBEHÖR

Für kombinierte Näh-und Stickmaschinen sowie für
reine Stickmaschinen

Erweitern Sie Ihr Know-how und werden Sie ein Experte für Stickerei und die Gestaltung von Mode, Accessoires und Dekotextilien. Dafür hat elna ein großes Sortiment von hochwertigem Zubehör speziell für Stickmaschinen ausgewählt. Nutzen Sie die Möglichkeiten Ihrer Stickmaschine und schöpfen Sie Ihre eigene Kreativität voll aus!



Zubehöre passend für folgende Nähmaschinen:

eXpressive 820 (elna 8200 und 8300)
eXpressive 830 und 830L
eXpressive 850 und 860
eXpressive 900
eXpressive 920
eXpressive 940 (elna 9900)
eXpressive 970

Hinweis: Die Vorgängermodelle der Maschinen aus dem aktuellen Sortiment werden in Klammern angezeigt.

Metallische Spule Groß



Ref. : 770-591-001



970

Füßchen-Set für Couching-Stickerei

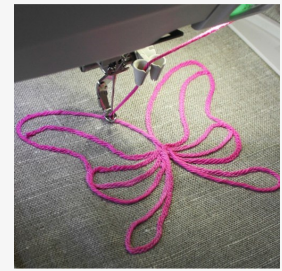

Ref. : 202-394-006



830/L, 920

Garntrichter



Ref. : 862-410-508



Zusätzliche Führung für die Füßchen-Set für Couching-Stickerei

Kappenrahmen 100 x 90 mm



Ref. : 859-436-005



900, 920

Kappenrahmen flach



Ref. : 770-489-005



940, 970

Rechteckiger Kappenrahmen - 100 x 90 mm



Ref. : 200-335-003



820, 830/L

Adapter für Monogramm Rahmen
J1 bis J8



Ref. : 770-482-008



940, 970

Monogramm Rahmen
J1 N°11 - 30 mm Durchmesser



Ref. : 770-487-704



940, 970

Monogramm Rahmen
J1 N°12 - 30 mm Durchmesser



Ref. : 770-487-807



940, 970

Monogramm Rahmen
J2 N°6 - 25x54 mm



Ref. : 770-487-302



940, 970

Sticken

Monogramm Rahmen
J3 N°13 - 64x28 mm



Ref. : 770-487-900



940, 970

Monogramm Rahmen
J4 N°8 - 42x67 mm



Ref. : 770-487-508



940, 970

Monogramm Rahmen
J5 N°3 - 46x46 mm



Ref. : 770-487-209



940, 970

Monogramm Rahmen
J6 N°2 - 66x66 mm



Ref. : 770-487-106



940, 970

Monogramm Rahmen
J6 N°9 - 66x66 mm



Ref. : 770-487-601



940, 970

Monogramm Rahmen
J7 N°1 - 110 x 95 mm



Ref. : 770-487-003



940, 970

Monogramm Rahmen
J8 N°7 - 120x121 mm



Ref. : 770-487-405



940, 970

Rahmenset für Socken



Ref. : 770-480-006



940, 970

Sticken

Freiarmrahmen - FA10a - 100 x 40 mm



Ref. : 861-407-004

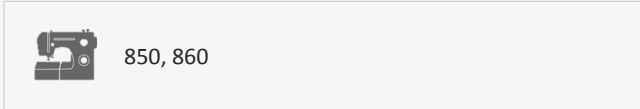

Rahmen Klein – M3 – 50 x 50 mm

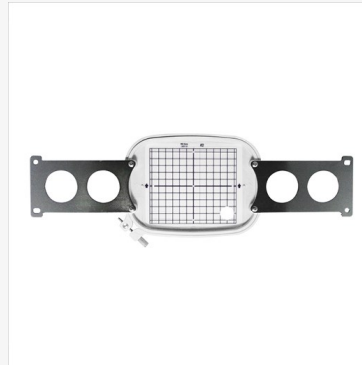

Ref. : 770-809-005

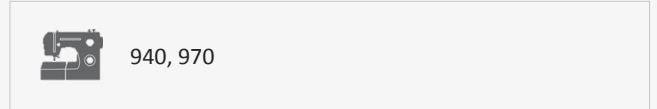

Rechteckrahmen - RE18 - 140 x 180 mm



Ref. : 859-451-006

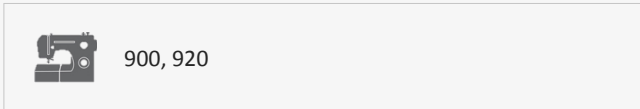

Rechteckrahmen groß - RE28b
200 x 280 mm



Ref. : 864-411-000

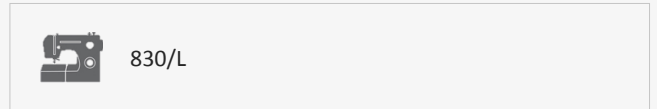

Rechteckrahmen Groß – M1
240 x 200 mm



Ref. : 770-807-003

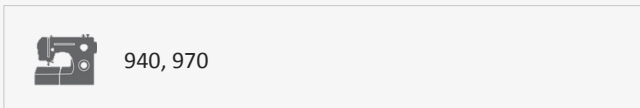

Rechteckrahmen klein - RE20b
140 x 200 mm



Ref. : 864-413-002

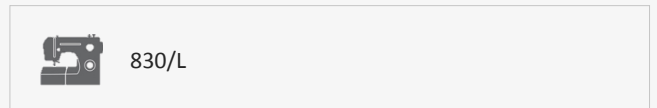

Rechteckrahmen Mittelgross – M2
126 x 100 mm

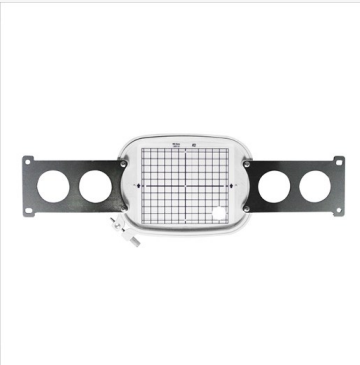

Ref. : 770-808-004

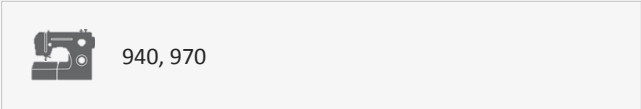

Rechteckrahmen sehr klein
RE10b - 100 x 40 mm



Ref. : 864-415-004

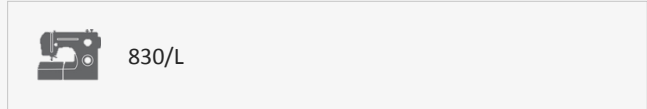

Viereckrahmen groß SQ20B
200 x 200 mm



Ref. : 864-412-001

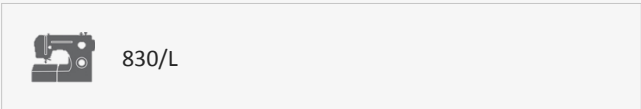

Viereckrahmen klein SQ14B
140 x 140 mm

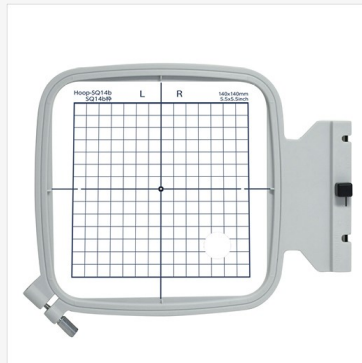

Ref. : 864-414-003

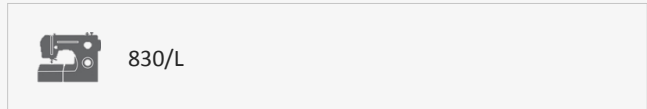

Sticken

Viereckrahmen Quilt-Set ASQ18B - 184 x 184 mm



Ref. : 864-410-009

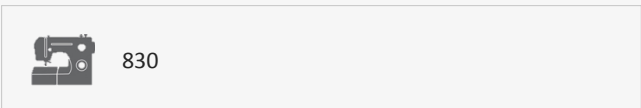

Viereckrahmen Quilt-Set ASQ18B V2.3 update



Ref. : 864-436-001

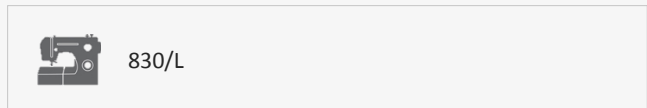

Viereckrahmen Quilt-Set ASQ22 220 x 220 mm



Ref. : 862-413-006



Anti-Slip-Tape für Stickrahmen



Ref. : 864-813-006



Brush-out-Set für Stickerei



Ref. : 200-383-028

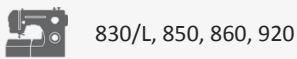

CD- DVD Laufwerk



Ref. : 860-429-009



Sticken

Einspannhilfe 1



Ref. : 859-442-200

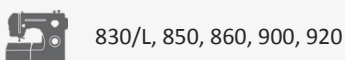

Spulenhalter zum Sticken



Ref. : 202-253-002

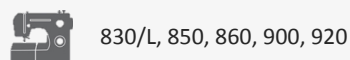

Stickdesign-Kollektion «Large embroidery designs collection»



Ref. : 202-296-007



900, 830/L, 920





OPTIONALES ZUBEHÖR

Für Overlock- und Coverstitch-Maschinen

Wenn Sie gerne verschiedenartige Stoffe verarbeiten und ein professionelles Nähergebnis erzielen möchten, unterstützt Sie dabei eine Overlock- oder Coverlock-Maschine aus dem elna Sortiment. Um das ganze Potential Ihrer Maschine zu nutzen, hat elna eine große Zubehör-Kollektion entwickelt, die Ihnen hilft, Ihre kreativen Projekte einfach und effektiv umzusetzen. Nähen Sie Säume und Rüschen, professionelle Versäuberungsnähte und Ziernähte.



Zubehöre passend für folgende Nähmaschinen:

eXtend 264
eXtend 664 and 664PRO
eXtend 745 and 845
eXtend 864*air*
eXtend covermax
eXtend *easycover* (elna 434 and 444)

Hinweis: Die Vorgängermodelle der Maschinen aus dem aktuellen Sortiment werden in Klammern angezeigt.

1/8 Inch und 3/16 Inch Paspelfuß



Ref. :202-039-011



264, 664/PRO, 864air

Bandaufnähuß (Q)

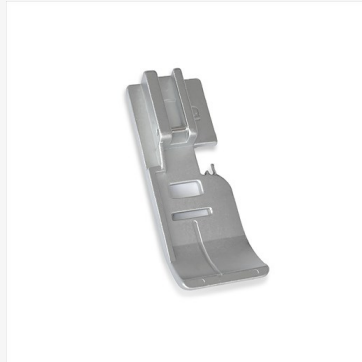

Ref. :496-245-20



745, 845

Biesenfuß (K)



Ref. :200-802-202



745, 845

Blindstichfuß (D)



Ref. :202-040-015



264, 664/PRO, 864air

Blindstichfuß (D)



Ref. :202-255-004



745, 845

Decksaumfuß (R)



Ref. :797-812-004



845

Decksaumfuß (M)



Ref. :200-801-304

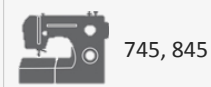

Gürtelschlaufenfuß



Ref. :200-808-002



Klarsichtfuß mit zwei Führungen



Ref. :202-247-003

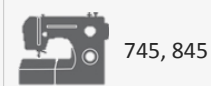

Klarsichtfuß (F)



Ref. :200-803-306



Overlock und Coverlock

Kordelfuß - Typ A



Ref. :202-034-016

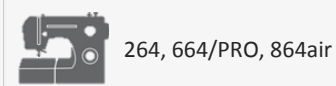

Kordelfuß - Typ B

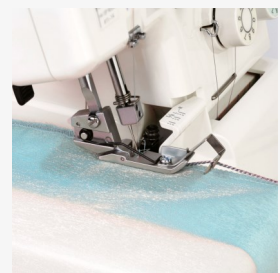
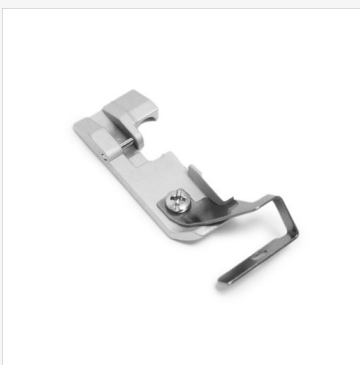

Ref. :202-035-017

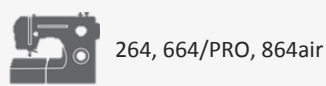

Kräuselfuß



Ref. :200-248-008



264, 664/PRO, 864air

Kräuselfuß mit Führung

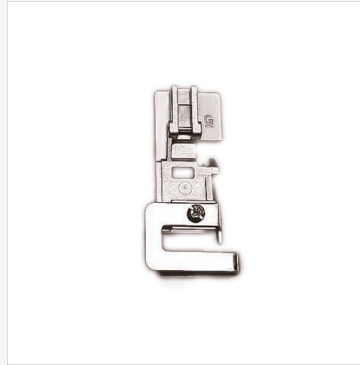

Ref. :200-807-001



745, 845

Mehrzweckfuß



Ref. :200-805-009



745, 845

Metall-Einfassbandfuß (in den Sätzen 795-838-114 und 795-844-032 enthalten)



Ref. :795-825-004



easycover, covermax

Mittelkantenfuß



Ref. :795-819-11



easycover, covermax

Paspelfuß (E)

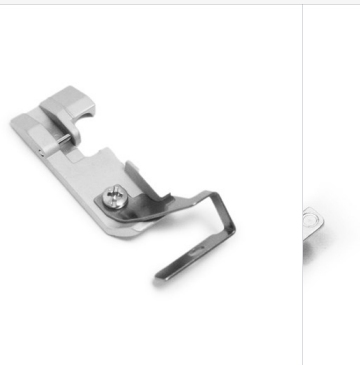

Ref. :200-814-104



745, 845

Perlernaufnähuß mit Führung



Ref. :202-041-119



264, 664/PRO

Steppfuß Covernaht (N)



Ref. :200-804-101



745, 845

Transparenter Coverstitch fuß



Ref. :795-818-118



easycover, covermax

Transparenter Einfassbandfuß mit Führung (dieser Fuß ist in den Sets Nr.



Ref. :796-402-004



easycover, covermax

Transparenter Perlernaufnähuß

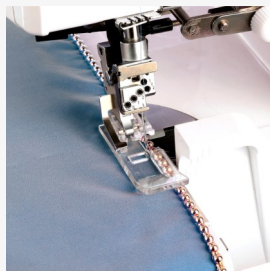

Ref. :200-809-003



745, 845

Verstellbarer Schrägbandfuß (M)

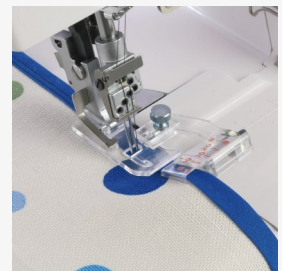

Ref. :200-810-007



745, 845

Decksaumfuß mit drei Führungen:
H-1, H-2 und H-3



Ref. :202-254-003



745, 845

Mehrzweckfuß mit drei
Gummibandkräuslern



Ref. :202-248-004



745, 845

Bandeinfassführung - schmal mit
transparentem Einfassbandfuß (8mm)



Ref. :202-403-009



easycover

Bandeinfassführung - breit mit Metall-
Einfassbandfuß(Fuß separat erhältlich,
Nr.795-825-004)

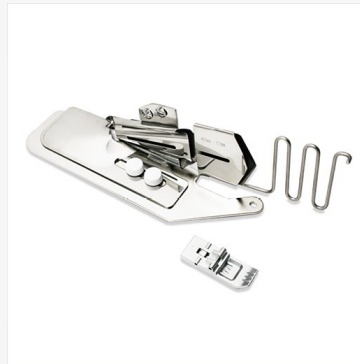

Ref. :795-844-032



easycover, covermax

Bandeinfassführung - breit mit
transparentem Einfassbandfuß (12mm)
(Fuß separat erhältlich, Nr. 796-402-004)



Ref. :202-404-000



easycover

Bandeinfassführung - schmal mit Metall-
Einfassbandfuß (Fuß separat erhältlich,
Nr. 795-825-004)

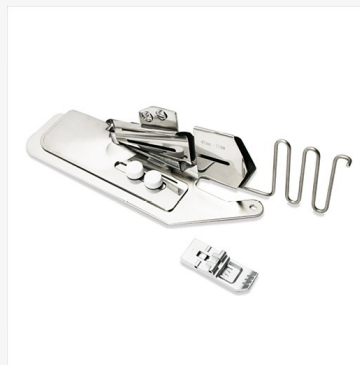

Ref. :795-838-114



easycover, covermax

Bandführung

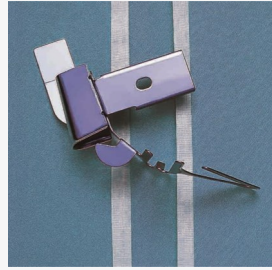

Ref. :200-814-001

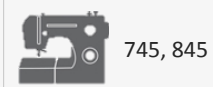

Biesenführung



Ref. :200-802-006

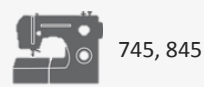

Führunglineal



Ref. :797-881-004

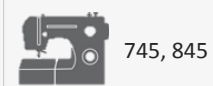

Hohlsaumführung (F-2)



Ref. :200-803-007

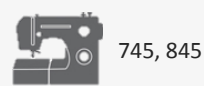

Kappnahtführung (F-4)



Ref. :200-803-203

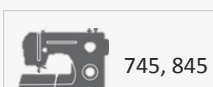

Kordelführung



Ref. :200-802-305

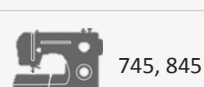

Kräuselführung



Ref. :202-036-111



264, 664, 664PRO, 864Air

Kurvenführung



Ref. :200-812-009



745, 845

Runde Garnführung



Ref. :797-343-009



845

Saumführung (H-2)



Ref. :200-801-108



745, 845

Saumführung Coverlock



Ref. :795-839-115



easycover, covermax

Schrägband- und Gürtelschlaufenführung



Ref. :202-464-101

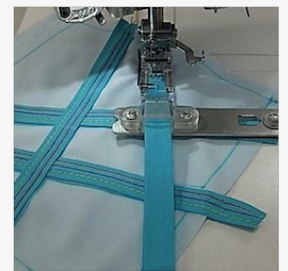

easycover, covermax

Schrägbandführung (H-3)



Ref. :200-801-201

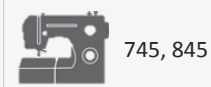

Spitzenführung (H-1)

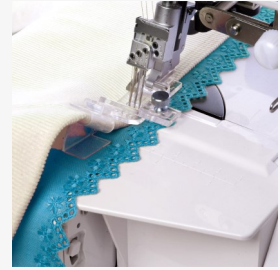

Ref. :200-801-005

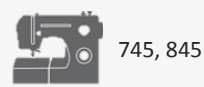

Spitzenführung (F-3)



Ref. :200-803-100

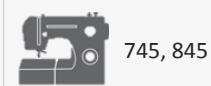

Steppführung (N-1)



Ref. :200-804-008

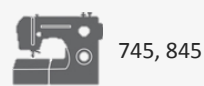

Stoffführung



Ref. :202-038-010

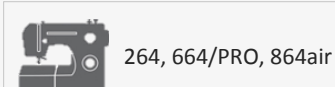

Stoffführung



Ref. :396-001-42



Verstellbares Führunglineal



Ref. :795-806-113



easycover, covermax

Zusatzgarnführung

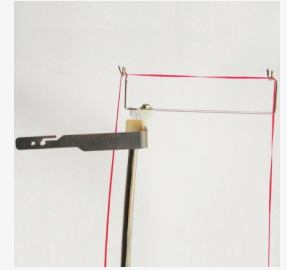

Ref. :200-811-008



745, 845

Bandführung



Ref. :202-033-015



264, 664/PRO

Behälter für Nähreste



Ref. :202-460-004



264

Behälter für Nähreste



Ref. :797-866-106



745, 845

Behälter für Nähreste (design 2022)



Ref. :798-042-A01



664/PRO

Decksaum-Haken



Ref. :797-342-008



Gummibandkräusler



Ref. :202-037-019

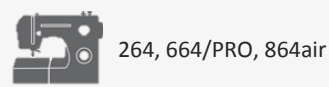

Gummibandkräusler - 10 mm breit

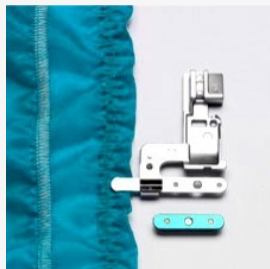

Ref. :200-805-205

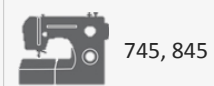

Gummibandkräusler - 13 mm breit

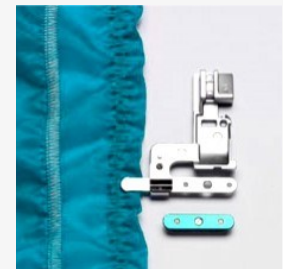
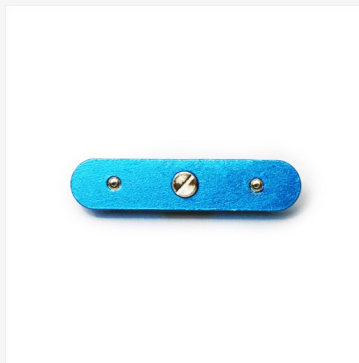

Ref. :200-805-308

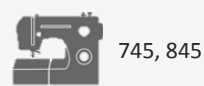

Gummibandkräusler - 7,5 mm breit

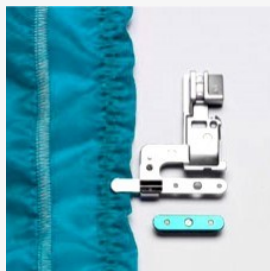

Ref. :200-805-102



Gummibandkräusler - breit

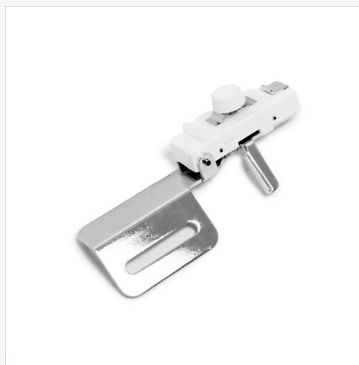

Ref. :795-817-117

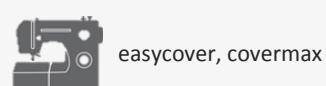

Gummibandkräusler - schmal



Ref. :795-816-116



easycover, covermax

Zubehörhalter-Set



Ref. :200-812-102



745, 845

elna
SWISS DESIGN





ALLGEMEINES ZUBEHÖR

Diese Kategorie enthält alle Artikel, die Sie für eine optimale Nutzung Ihrer elna Nähmaschine benötigen.

Von Spulen bis zu Nähtischen und Transporttaschen können diese Zubehörteile Ihr Arbeitsumfeld verbessern und vor allem Ihre Arbeit erleichtern!



In dieser Kategorie können Sie Zubehör für Nähmaschinen, Stickmaschinen sowie Overlock- und Coverstitch-Maschinen finden.

elna Trolley-Tasche
B: 56 cm x H:45 cm T: 34 cm



Ref. :395-800-01

 Lotus/2, 450, 520/S, 540/S, 530, 550, 560, 570/α, 580/+, 680/+, 720PRO, 770, 780/+, 782, 792PRO, 850, 860, 264, 664/PRO, 864air, easycover,

elna Tasche für Overlock- /
Coverlockmaschine



Ref. :395-800-02

 264, 664/PRO, 864air, easycover, covermax

elna Zubehörbeutel
33 x 26 cm (LxH)



Ref. :395-800-03

 Universal



Einsatz für elna Zubehörbeutel



Ref. :395-800-04

 Zusätzliche Einsatz für elna Zubehörbeutel 395-800-03

Zubehörbox für elna-Zubehöre - großes
Modell



Ref. :866-801-018

 Universal

Zubehörbox für elna-Zubehöre - kleines
Modell



Ref. :843-823-004

 Universal

Allgemeines Zubehör

elna Tragetasche



Ref. :849-802-005



Sew, 150, 160, 220, 240, 320, 340, 3210j, Star, Lotus/2, 450, 520/S, 540/S, 530, 550, 560, 570/α, covermax, easycover

Feste Kofferhaube



Ref. :404-701-404



530, 550, 560, 570/α,

Allgemeines Zubehör

Softhaube 415 x 320 x 280 mm (LxHxT)



Ref. :849-804-007



520/S, 540/S

Softhaube 480 x 340 x 250 mm (LxHxT)



Ref. :846-831-004



720

Softhaube 520 x 340 x 360 mm (LxHxT)



Ref. :861-806-100



580/+, 680/+ 850, 860

Softhaube 540 x 340 x 260 mm (LxHxT)



Ref. :858-802-069



720PRO, 730/PRO, 760/PRO, 770, 780/+, 782, 792PRO

Tragetasche und Schutzhaube
42 x 29 x 18 cm (LxHxT)



Ref. :395-800-15

Sew, 150, 160, 220, 240, 320, 340, 3210j, Star, 450, 520/S, 540/S, 530, 550, 560, 570/α

Spulenhalter zum Freihandquiltten



Ref. :202-495-008

790PRO, 792PRO

Spulenkapsel - Metall



Ref. :395-710-08

Sew, 220, 240

Spulenkapsel - Metall



Ref. :770-590-000

970

elna Spule



Ref. :395-751-83

Universal

elna Spulen (x10)



Ref. :200-122-027

Universal

Allgemeines Zubehör

Spule "easy bobbin"



Ref. :202-192-404

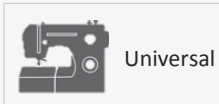

Spulen "easy Bobbin" - Box mit 10 Spulen



Ref. :202-260-002

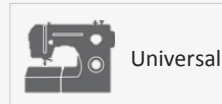

USB-stick



Ref. :395-741-60

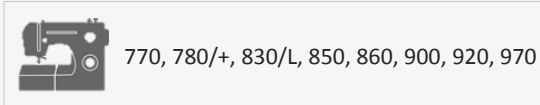

Garnrollenträger für zwei Garnrollen



Ref. :202-513-003

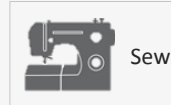

Fadenabschneiderpedal



Ref. :865-810-006

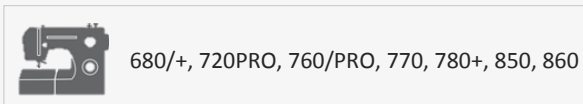

Großer Fußanlasser



Ref. :858-417-007

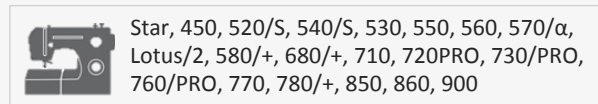

Set mit Fadenabschneiderpedal und Fußanlasser groß



Ref. :858-418-008



720, 680/+, 720PRO, 760/PRO, 770, 780/+, 850, 860, 900

Fingerschutz

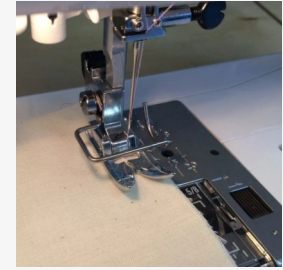

Ref. :687-803-008



Sew, 150, 160, 220, 240, 320, 340, 3210j, Star, Lotus/2, 450, 520/S, 540/S, 530, 550, 560, 570/α, 580/+, 680/+, 720PRO, 760/PRO, 770, 780/+, 782,

Bandhalter (für Einfassband)

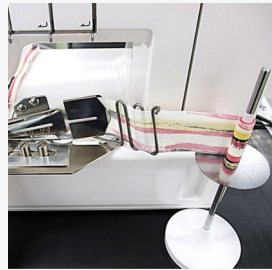

Ref. :202-402-008



Lotus, Lotus/2, 580/+, 680/+, 720, 720PRO, 770, 780/+, 782, 792PRO, 850, 860, 920, easycover, covermax

elna Matte



Ref. :301-804-004



Sew, 150, 160, 220, 240, 320, 340, 3210j, Star, Lotus/2, 450, 520/S, 540/S, 530, 550, 560, 570/α, 580/+, 680/+, 264, 664/PRO, 745, 845, 864air,

Allgemeines Zubehör

Kniehebel



Ref. :846-417-022



770

Kreisnähstift

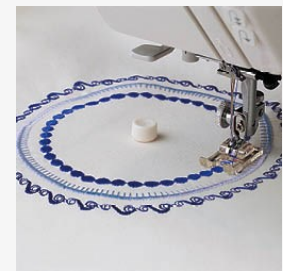

Ref. :849-801-004



220, 240, 620, 660, 580, 580+, 680/+, 730/PRO, 760/PRO, 770, 780, 780+, 850, 860, 920

Teppichgabel

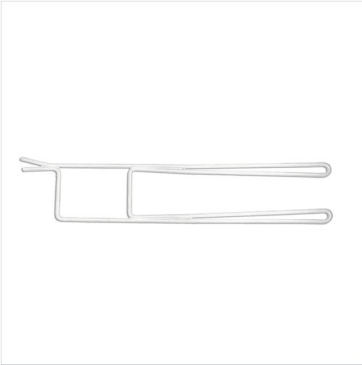

Ref. :424-630-10



Universal

Fadenabzugsscheibe: groß



Ref. :822-020-503



150, 160, 320, 340, 3210j, Star, 450, 520/S, 540/S, 530, 550, 560, 570/α, 580/+, 680/+, 720PRO, 730/PRO, 760/PRO, 770, 780/+, 830/L, 850, 860, 900,

Fadenabzugsscheibe: klein



Ref. :822-019-509



150, 160, 320, 340, 3210j, Star, 450, 520/S, 540/S, 530, 550, 560, 570/α, 580/+, 680/+, 720PRO, 730/PRO, 760/PRO, 770, 780/+, 830/L, 850, 860, 900,

Fadenabzugsscheibe: spezial

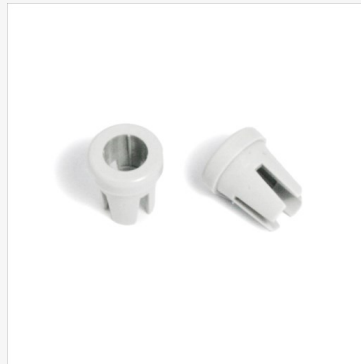

Ref. :202-240-006



150, 160, 320, 340, 3210j, Star, 450, 520/S, 540/S, 530, 550, 560, 570/α, 580/+, 680/+, 720PRO, 730/PRO, 760/PRO, 770, 780/+, 830/L, 850, 860, 900,

Garnrollenträger für fünf Garnrollen



Ref. :859-450-005



580/+, 680/+ 770, 780/+, 782, 792PRO, 830/L, 850, 860, 900, 920

Garnrollenträger für zwei Garnrollen



Ref. :859-449-012



580/+, 680/+ 730/PRO, 760/PRO, 770, 780/+, 782, 792PRO, 830/L, 850, 860, 900, 920



Nadelkissen - blau



Ref. :202-256-027



150, 160, 320, 340, 3210j, 450, 520/S, 540/S, 530, 550, 560, 570/α, 580/+, 680/+, 770, 780/+, 782, 792PRO, 850, 860, 920

Nadelkissen - gelb



Ref. :202-256-038



150, 160, 320, 340, 3210j, 450, 520/S, 540/S, 530, 550, 560, 570/α, 580/+, 680/+, 770, 780/+, 782, 792PRO, 850, 860, 920

Nadelkissen - rosa



Ref. :202-256-005



150, 160, 320, 340, 3210j, 450, 520/S, 540/S, 530, 550, 560, 570/α, 580/+, 680/+, 770, 780/+, 782, 792PRO, 850, 860, 920

Nadelkissen - weiss



Ref. :202-256-016



150, 160, 320, 340, 3210j, 450, 520/S, 540/S, 530, 550, 560, 570/α, 580/+, 680/+, 770, 780/+, 782, 792PRO, 850, 860, 920

Allgemeines Zubehör

Zusätzlicher Garnrollenhalter



Ref. :395-710-23



Lotus/2

Anschietisch



Ref. :489-709-508



720

Anschietisch (40cm x 28cm)



Ref. :502-403-008



450

Anschietisch (45cm x 24,5cm)



Ref. :491-701-138



520/S, 540/S

Anschietisch für die Coverlock
(29.5cm x 20.5cm)



Ref. :795-812-307



easycover, covermax

Anschietisch für Stickmaschinen
(43cm x 38cm)

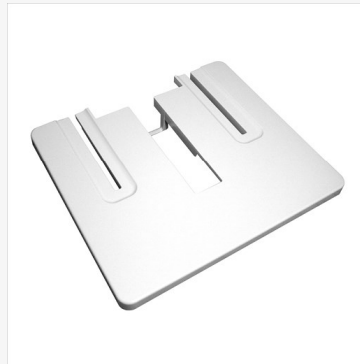

Ref. :770-814-003



940, 970

Extragroßer Anschietisch
(40cm x 28cm)



Ref. :811-806-002



530, 550, 560, 570/α

Extragroßer Anschietisch mit
Stoffführungs-Set (61cm x 40cm)



Ref. :858-419-010



710, 730/PRO, 760Pro

Näh- und Quilt-Anschiebetisch



Ref. :506-803-004

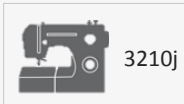

Nähtisch



Ref. :399-000-78

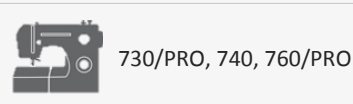

Nähtisch mit Schublade und ohne Einsatzplatte



Ref. :494-719-002

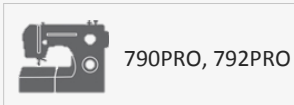

Transparenter extragroßer Anschietisch



Ref. :865-812-008

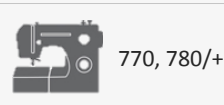

Transparenter extragroßer Anschietisch 50cm x 31cm



Ref. :861-406-025

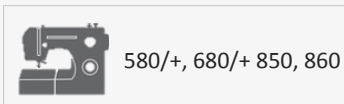

Beistelltisch 115 x 45 x 76 cm (BxTxH)



Ref. :494-709-009

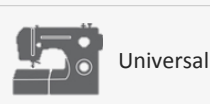

Nähtisch mit Schublade aber ohne Einsatzplatten



Ref. :494-710-003



580/+, 680/+, 720, 720PRO, 730PRO, 760PRO, 770, 780/+, 782, 850, 860, 900, 920

Nähtisch mit Schublade und Einsatzplatten A, B und C



Ref. :494-711-004



710, 720, 730PRO, 760PRO, 900

Nähtisch ohne Schublade und ohne Einsatzplatte



Ref. :494-708-101



580/+, 680/+, 710, 720, 720PRO, 730PRO, 760PRO, 770, 780/+, 782, 850, 860, 900, 920

Optionales Regal / Schublade für Nähtisch 494-708-101



Ref. :494-708-204



580/+, 680/+, 720, 720PRO, 730PRO, 760PRO, 770, 780/+, 782, 850, 860, 900, 920

Seitentaschen für den Nähtisch



Ref. :494-805-006



Universal

Einsatzplatte A



Ref. :494-401-101



710, 730PRO, 760PRO, 900

Einsatzplatte B



Ref. :494-402-102

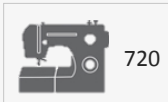

720

Einsatzplatte D



Ref. :494-405-105

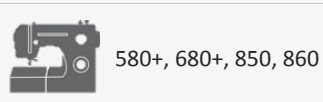

580+, 680+, 850, 860

Einsatzplatte E



Ref. :494-406-106

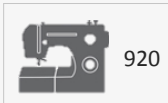

920

Einsatzplatte G



Ref. :494-408-108

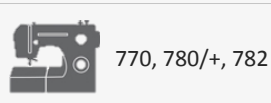

770, 780/+, 782

Einsatzplatte H



Ref. :494-712-005

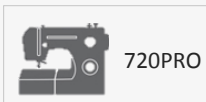

720PRO

Einsatzplatte K



Ref. :494-411-104

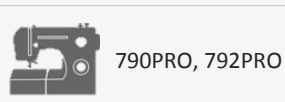

790PRO, 792PRO

Einfädler für den Untergreifer



Ref. :784-806-005



Nadeleinfädler universell



Ref. :200-347-020

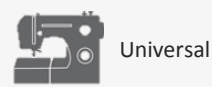

Nahttrenner



Ref. :200-133-021



Ölfläschchen



Ref. :741-814-003

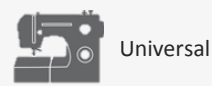

Pinsel



Ref. :802-424-004

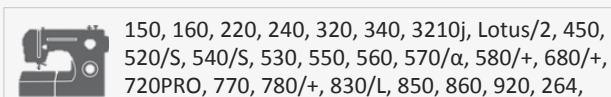

Pinzette



Ref. :624-801-001

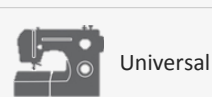

Schraubendreher - kurz



Ref. :820-832-005

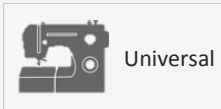

Schraubendreher - schmal



Ref. :647-803-004

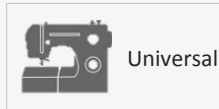

Cutwork-Nadelset: 0°, 45°, 90°, 135°



Ref. :202-298-009

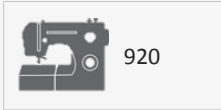

Nadeln mit blauem Schaft: 75/11 - für synthetische Stoffen



Ref. :200-346-029



Nadeln mit lilafarbenem Schaft: für schwere Stoffen - 90/14



Ref. :202-244-000

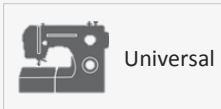

Nadeln mit rotem Schaft: für mittelschwere bis schwere Stoffen - 90/14

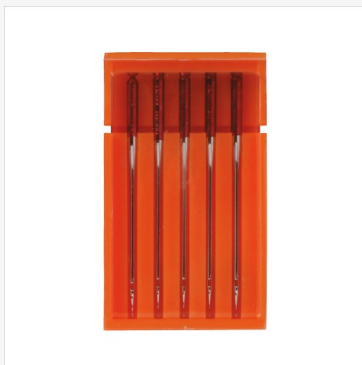

Ref. :990-314-132

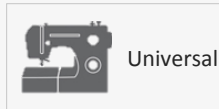

Universal-Nadelset: 1x Zwillingnadel, 2x 75/11, 1x 90/14, 1x Nadel mit blauem



Ref. :200-343-026



Universal

Universal-Nadelset: 2x 75/11, 1x Nadel mit blauem Schaft, 2x 90/14



Ref. :200-135-023



Universal



STANDARD NADELN

NADELN

Kategorie - ModellW - Reference

5-7 mm	Sew, 159, 160, 220, 240, 450	639-804-000
5-7 mm	320, 340, 3210J, 530, 550, 560, 570a	540-401-026
5-7 mm	580+	820-827-007
9 mm	680+, 710, 720PRO, 730PRO, 770, 780+, 782, 790PRO, 792PRO, 850, 920	859-856-005
Sticken	830, 830L	852-802-108
Overlock	264, 664, 664PRO, 864air, 845	784-860-100
Coverstitch	easycover, covermax	795-802-005

Die Nadeln

Für jeden Stoff gibt es die passende Nadel. Viele Probleme und Fehler können vermieden werden, wenn die richtige Nadel verwendet wird.

Alle Nadeln in der folgenden Liste sind Schmetz Nadeln.

UNIVERSAL-NADELN Bezeichnung und Typ - Sortierung - Artikelnummer

System 130/705 H: Mit leicht gerundeter Spitze, für einwandfreies Nähen von vielen Materialien.

Nadeln H 60/8	Universal-Nadeln, 5 Stück, Größe 60	424-830-10
Nadeln H 70/10	Universal-Nadeln, 5 Stück, Größe 70	424-840-10
Nadeln H 80/12	Universal-Nadeln, 5 Stück, Größe 80	424-850-10
Nadeln H 90/14	Universal-Nadeln, 5 Stück, Größe 90	424-860-10
Nadeln H 100/16	Universal-Nadeln, 5 Stück, Größe 100	424-870-10
Nadeln H 110/18	Universal-Nadeln, 5 Stück, Größe 110	424-880-10
Nadeln H 120/19	Universal-Nadeln, 5 Stück, Größe 120	424-890-10
Nadeln H 70/80/90	Universal-Nadeln-Sortiment: 2x70 / 2x80 / 1x90	424-451-20

Zwillings- und Drillings-Universal-Nadeln

Nadeln H-ZWI 70/1,6	Zwillingsnadeln 1,6 mm Universal, 2 Stück, Größe 70	427-185-20
Nadel H-ZWI 80/2,0	Zwillingsnadel 2 mm Universal, 1 Stück, Größe 80	427-630-10
Nadel H-ZWI 80/4,0	Zwillingsnadel 4 mm Universal, 1 Stück, Größe 80	427-610-10
Nadel H-ZWI BR 100/6,0	Zwillingsnadel 6 mm Universal, 1 Stück, Größe 100	427-611-10
Nadel H-DRI 80/2,5	Drillingsnadel 2,5 mm Universal, 1 Stück, Größe 80	427-045-20
Nadel H-DRI 80/3,0	Drillingsnadel 3 mm Universal, 1 Stück, Größe 80	427-046-20
Nadeln H-ZWI 80/2,0-2,5-4	Zwillingsnadel-Sortiment 1x80/2 1x80/2,5 1x80/4	427-680-20

LEDER

System 130/705 H LL: Mit Schneidspitze für leichtes Durchdringen des Materials. Für Leder, Kunstleder und ähnliche Materialien.

Nadeln H-LL 80/12	Ledernadeln, 5 Stück, Größe 80	424-495-20
Nadeln H-LL 90/14	Ledernadeln, 5 Stück, Größe 90	424-490-20
Nadeln H-LL 100/16	Ledernadeln, 5 Stück, Größe 100	424-491-20
Nadeln H-LL 110/18	Ledernadeln, 5 Stück, Größe 110	424-492-20

OVERLOCK / COVERLOCK

System ELx705: Stabiler durch verstärkten Schaft. Mit langer Hohlkehle für Kettenstiche und Overlock-/Coverlock-Stiche.

Nadeln ELx705 80/12	Nadeln overlock/coverlock, 5 Stück, Größe 80	396-013-92
Nadeln ELx705 90/14	Nadeln overlock/coverlock, 5 Stück, Größe 90	396-013-93
Nadeln ELx705 80/90	Nadeln assortment overlock/coverlock: 2x80 / 3x90	396-002-27

JEANS UND DENIM

System 130/705 H-J: Die mittlere Kugelspitze durchdringt leichter dicke und stabile Stoffe, ohne das Material zu beschädigen. Der verstärkte Schaft verringert die Gefahr von Nadelbruch und Fehlstichen.

Nadeln H-J 70/10	Jeansnadeln, 5 Stück, Größe 70	424-265-20
Nadeln H-J 90/14	Jeansnadeln, 5 Stück, Größe 90	424-260-20
Nadeln H-J 100/16	Jeansnadeln, 5 Stück, Größe 100	424-261-20
Nadel H-J ZWI 100/4,0	Zwillingsnadel 4 mm für Jeans, 1 Stück, Größe 100	427-615-20

STRETCH

Bezeichnung und Typ - Sortierung - Artikelnummer

System 130/705 H-S: Mit mittlerer Kugelspitze. Das spezielle Nadelöhr und die spezielle Hohlkehle vermeiden Fehlstiche, besonders in hochelastischem Material. Für elastische Stoffe und hochelastische Maschenwaren.

Nadeln H-S 75/11	Stretchnadel, 5 Stück, Größe 75	424-245-20
Nadeln H-S 90/14	Stretchnadel, 5 Stück, Größe 90	424-240-20
Nadel H-S ZWI 75/2,5	Zwillingsnadel 2,5 mm für Stretch, 1 Stück, Größe 75	427-176-20
Nadeln H-S ZWI 75/2,5	Zwillingsnadel 2,5 mm für Stretch, 2 Stück, Größe 75	427-175-20
Nadeln H-S ZWI 75/4,0	Zwillingsnadel 4 mm für Stretch, 2 Stück, Größe 75	424-246-20

JERSEY / KUGELSPITZE

System 130/705 H SUK: Mit mittlerer Kugelspitze, für Maschenware.

Nadeln H-SUK 70/10	Jerseynadeln, 5 Stück, Größe 70	424-845-10
Nadeln H-SUK 90/14	Jerseynadeln, 5 Stück, Größe 90	424-865-10
Nadeln H-SUK 70/80/90	Nadelsortiment für Jersey: 2x70 / 2x80 / 1x90	427-155-20

MICROTEX

System 130/705 H-M: Sehr schlanke, spitze Nadelspitze für ein leichtes Einstechen in sehr feine oder dicht gewebte Stoffe. Für das präzise Absteppen von Kanten. Für Seide, Microfaser, beschichtete Materialien, Folie und Kunstleder.

Nadeln H-M 70/10	Microtexnadeln, 5 Stück, Größe 70	424-841-10
Nadeln H-M 80/12	Microtexnadeln, 5 Stück, Größe 80	424-851-10
Nadeln H-M 60/70/80	Microtex-Nadelsortiment: 2x60 / 2x70 / 1x80	424-452-20

HOHLSAUMNADEL

System 130/705 H WING: Mit einem Flügel auf jeder Seite des Nadelschafts, der den Stoff beiseite drängt. Für dekorative Nähte und Hohlsaumeffekte in lose gewebten Stoffen.

WING-Nadel 100/16	Hohlsaumnadel, 1 Stück, Größe 100	427-240-20
WING-Nadel 120/19	Hohlsaumnadel, 1 Stück, Größe 120	427-245-20
Nadel ZWIHO 100	Zwillingsnadel 3 mm, 1 Stück, Größe 100	427-042-20
Nadeln ZWIHO 100	Zwillingsnadeln 3 mm, 2 Stück, Größe 100	427-041-20
Nadeln ZWIHO 100	Zwillingsnadeln 3 mm, 3 Stück, Größe 100	427-040-20

QUILTEN

System 130/705 H-Q: Spezielle Form der leicht verrundeten Spitze, die dicke Lagen einfach durchsticht, ohne das Material zu beschädigen.

Nadeln H-Q 75/90	Nadelsortiment Quilten: 3x75 / 2x90	424-455-20
------------------	-------------------------------------	------------

STICKEN

System 130/705 H-E: Mit leicht verrundeter Kugelspitze und besonders breitem Nadelöhr und breiter Rinne, so dass auch voluminöse Garne oder Wollgarne verarbeitet werden können.

Nadeln H-E 75/90	Nadelsortiment Sticken: 3x75 / 2x90	424-456-20
------------------	-------------------------------------	------------

METALLIC GARNE

System 130 MET: Mit einem sehr langen Nadelöhr (2 mm) für besondere Effekte mit Fantasiegarnen, besonders für Metallicgarne geeignet.

Nadeln H-M 90/14	Nadel für Metallicgarne, 5 Stück, Größe 90	424-861-10
------------------	--	------------





crafted with love

Elna International Corp. SA, Genève, Suisse

Sous réserve de modification sans préavis

© 2023

elna.com